

AN ABSTRACT OF THE THESIS OF

Joseph W. Booth for the degree of Master of Science in

Biochemistry and Biophysics presented on June 9, 1988.

Title: Attempted Cloning of T4 Phage Ribonucleotide Reductase

Abstract approved: *Redacted for Privacy*

Ribonucleotide reductase is an important enzyme in the control of DNA replication within the cell. Ribonucleotide reductase exerts its control through enzymatic reduction of nucleoside diphosphates. The bacteriophage T4 enzyme is an example of the class of iron-requiring reductases which also includes E. coli and mammalian ribonucleotide reductases. The two genes coding for the E. coli ribonucleotide reductase have at this time been cloned, sequenced and cloned into expression vectors. Many other ribonucleotide reductase genes have also been cloned. To date, however, only one of the two genes which code for Bacteriophage T4 ribonucleotide reductase has been cloned

although fragments have been sequenced. It was the objective of this work to clone both of the genes for Bacteriophage T4 ribonucleotide reductase into high expression vectors

The work of a different laboratory has demonstrated that at least one of the genes of T4 ribonucleotide reductase is contained on a 5.2 kb Hind III fragment. This thesis work describes the cloning of this 5.2 kb fragment into different plasmid vectors and the attempt to achieve over-expression of the T4 ribonucleotide reductase subunits. One recombinant plasmid containing the 5.2 kb fragment expressed a 60 kDa peptide. This peptide appears to be part of the large subunit of ribonucleotide reductase. Owing to its poor solubility in aqueous solutions, attempts to purify the 60 kDa peptide were not successful.

Attempted Cloning of T4 Phage
Ribonucleotide Reductase

By

Joseph Booth

A THESIS

submitted to

Oregon State University

In partial fulfillment
of the requirements for the
degree of

Master of Science

Completed June 9, 1988

Commencement June 1989

APPROVED:

Redacted for Privacy

Professor and Head of department of Biochemistry and Biophysics

Redacted for Privacy

Dean of Graduate Studies

Date thesis is presented June 9, 1988

TABLE OF CONTENTS

	Page
INTRODUCTION	1
A. Deoxyribonucleotides	1
B. Types of RDPR enzymes	1
1. Iron-requiring RDPR enzymes	2
a. The <u>E. coli</u> RDPR	3
b. The Bacteriophage T4 RDPR	5
c. The mammalian RDPR	6
2. B ₁₂ -requiring RDPR enzymes	7
3. Manganese-requiring RDPR enzymes	9
4. Viral RDPR enzymes	9
C. Allosteric control	11
1. Specificity and activity sites	11
2. Allosteric regulation: T4 and <u>E. coli</u>	12
D. Hydrogen donor systems	14
E. Reaction mechanisms	16
F. RDPR as member of enzyme aggregate	19
G. Bacteriophage T4 introns	21
H. Cloning and sequencing T4 RDPR	23
I. Clonability/Unclonability	24
J. Purpose of current work	25
MATERIALS AND METHODS	26
A. Enzymes for cloning	26
B. Preparation of T4 C-DNA and plasmid DNA	27
C. Purification of DNA fragments	29
D. DNA gels	31
E. DNA sequencing	31
F. Labeling of plasmid-coded proteins	33
G. 60-kDa peptide: Cell culturing and assay for RDPR	33
H. 60-kDa peptide: Solubility tests and initial purification	34
I. 60-kDa peptide: Column chromatography	35

Table of Contents (continued)

RESULTS AND DISCUSSION	39
A. Cloning the 5.2 kb-Hind III fragment into pBR 322	39
B. Cloning the 5.2-kb Hind III fragment into expression vector pKC 30	41
C. Cloning fragments downstream of the 5.2-kb Hind III fragment	48
D. DNA sequencing in the 0.7-kb Eco RI fragment	49
E. ³⁵ S Autoradiography of pKC 13 extracts	53
F. The attempt to clone the 8.2-kb Sal I-Cla I fragment	54
G. Cloning the 5.2-kb Hind III fragment into the pT73 vector	57
H. Attempted purification of the 60-kDa peptide	58
REFERENCES	61
APPENDICES	65
A. Attempted cloning of T4 gene 1	65
B. Attempted cloning of T4 gene 42	70
C. Attempted cloning of T4 <u>frd</u> and <u>td</u>	70

LIST OF FIGURES

	Page
Fig. 1. Schematic of <u>E. coli</u> ribonucleotide reductase	4
Fig. 2. Schematic of <u>L. leichmannii</u> ribonucleotide reductase	8
Fig. 3. Schematic of regulation of dNTP biosynthesis in <u>E. coli</u>	13
Fig. 4. Components in RDPR electron transfer	15
Fig. 5. Mechanism of inactivation of RDPR	17
Fig. 6. Proposed RDPR reaction mechanism	18
Fig. 7. Schematic of T4 map between 133 and 145 units	40
Fig. 8. pKC 30 over-expression plasmid system	42
Fig. 9. Recombinant plasmid pKC 13 construction	44
Fig. 10. SDS PAGE gel of recombinant extracts	45
Fig. 11. Positioning of the <u>nrd</u> A gene on the 5.2 kb Hind III fragment	50
Fig. 12. Sequence of part of 0.7 kb Eco RI fragment beginning at 140.6	51
Fig. 13. T4/ <u>E. coli</u> amino acid homology	52
Fig. 14. Autoradiography of ³⁵ S-labeled peptides	53
Fig. 15. pT7 over-expression system	55
Fig. 16. Recombinant plasmid pT7-12 construction	56
Fig. A.1. Schematic of T4 map between 69 and 81 units	66
Fig. A.2. Fine restriction map of region of T4 between 70.3 and 75.5 units	68
Fig. A.3. Schematic of T4 map between 19 and 21 units	69

TABLE OF ABBREVIATIONS

RDPR	Ribonucleoside diphosphate reductase
rNDP	Nucleoside diphosphate
rNTP	Nucleoside triphosphate
ESR	Electron spin resonance
AdoCbo	Adeonsylcobalamine
ORF	Open reading frame
PAGE	Polyacrylamide gel electrophoresis
SDS	Sodium dodecyl sulfate
Da, kDa	Dalton, kilodalton
TBE	0.09 M Tris-borate, pH 8, 0.09 M EDTA
TAE	0.04 M Tris-acetate, pH 8, 0.002 M EDTA
BAP	Bacterial alkaline phosphatase
AMP-PNP	Adenylylibido-diphosphate
DEAE	Diethylaminoethyl
QAE	Quaternary aminoethyl
CM	Carboxymethyl
hmdCTP	Hydroxymethyldeoxycytidine triphosphate
moi	Multiplicity of infection
MPK	Deoxyribonucleoside monophosphokinase

The Attempted Cloning of the Bacteriophage T4 Ribonucleotide Reductase

INTRODUCTION

A. Deoxyribonucleotides

Ribonucleotide reductase (EC 1.17.4.1) catalyzes an important step in the synthesis of precursors for the making of DNA. The step involves the removal of the 2' hydroxyl group from the ribosyl moiety of ribonucleoside diphosphates (NDPs). After the removal of the hydroxyl group the deoxyribonucleotides (deoxyribonucleoside phosphates) pass through one or more enzymatic steps before polymerization into DNA. The generation of reduced nucleotides is highly important in the regulation of DNA synthesis. Ribonucleotide reductase (RDPR) represents the committing step to de novo deoxyribonucleotide biosynthesis by controlling reduction of ribonucleoside diphosphates to deoxyribonucleoside diphosphates. Deoxyribonucleotides are highly specialized metabolites and serve only as building blocks of DNA in the cell (Eriksson, S. and Sjoberg, B.-M., in press). Their concentrations are very low in non-growing cells but their presence is essential for the growth and differentiation of the organism.

B. Types of RDPR Enzymes

There are essentially three types of RDPR enzymes found among all living systems studied to date. The principal differences between

the RDPR types center on structural differences at the site of catalysis. One group is iron-requiring; one group requires a coenzyme B12 moiety; and one obscure group requires manganese at the catalytic center. There are vast differences in size and subunit composition in the RDPR enzymes as well. Among common features, all RDPR enzymes appear to catalyze ribonucleotide reduction utilizing a free radical. In one RDPR enzyme group the free radical is localized to a tyrosyl moiety which is stabilized by an iron-oxygen center; in another group the free radical is present on a coenzyme such as adenosylcobalamine; in the last group, the free radical has not been implicated to be on any enzyme structure, but appears to be stabilized by manganese. In addition, all RDPR enzymes require a peptide disulfide reductant such as thioredoxin to regenerate the oxidized dithiols of the RDPR catalytic machinery after the reduction of the substrate has occurred.

1. Iron-Requiring RDPR Enzymes

The most studied type of RDPR is the Fe^{3+} -requiring, tyrosyl radical- utilizing enzyme characteristic of E. coli, bacteriophage T4, and mammals. This enzyme possesses four polypeptide chains--two polypeptides make up the large subunit, and two polypeptides make up the small subunit as well. The polypeptides of the large subunit possess two catalytically active cysteine sulfhydryl groups in addition to two distinct binding sites for nucleoside triphosphate effectors. The interface between the large and small subunits forms

the catalytic site. The small subunit binds two Fe^{3+} atoms and possesses one tyrosyl free radical. The two iron atoms are not porphyrin-bound as in a heme, but are oxygen coordinated. The iron atoms can be removed from the RDPR enzyme by precipitation with acid ammonium sulfate. The iron-depleted apoprotein has no enzyme activity although it retains its subunit structure. The apoprotein can be reconstituted by treatment with a solution of Fe^{2+} ascorbate. The Fe^{3+} -type enzyme, owing to its free radical-containing nature, has a characteristic absorption spectrum--a broad peak at 370 nm, a sharp peak at 410 nm, and the characteristic protein peak at 280 nm (Brown, N. C., Eliasson, R., Reichard, P., Thelander, L., 1969). Fe^{3+} -requiring RDPR enzymes also have easily recognizable ESR signals consisting of a doublet around $g = 2.0047$ (Ehrenberg, A. and Reichard, P., 1972). When the iron atoms are removed, the doublets in the spectra completely disappear. The doublets in the ESR spectrum are representative of the presence of tyrosyl free radicals in the small subunit of RDPR.

a. The *E. coli* RDPR

The *E. coli* enzyme has been the prototype RDPR for more than 20 years. It is the best studied of the RDPR enzymes. Among other firsts, it was the first of its kind in which the link between RDPR enzyme, thioredoxin, thioredoxin reductase, and NADPH was understood; the *E. coli* RDPR was also the first whose genes were cloned and sequenced (Carlson, J., Fuchs, J., Messing, J., 1984; Platz,

A. and Sjöberg, B.-M., 1980). Among the bacterial RDPR enzymes studied to date, it is unusual to find one having the catalytic properties and the 2 nonidentical subunits that the E. coli enzyme possesses. The E. coli enzyme possesses all of the features listed above as common to Fe^{3+} -requiring RDPR enzymes. It possesses 2 nonidentical subunits, the larger denoted B1, of 80,000 kDa, and a smaller, denoted B2 of 39,000 kDa.

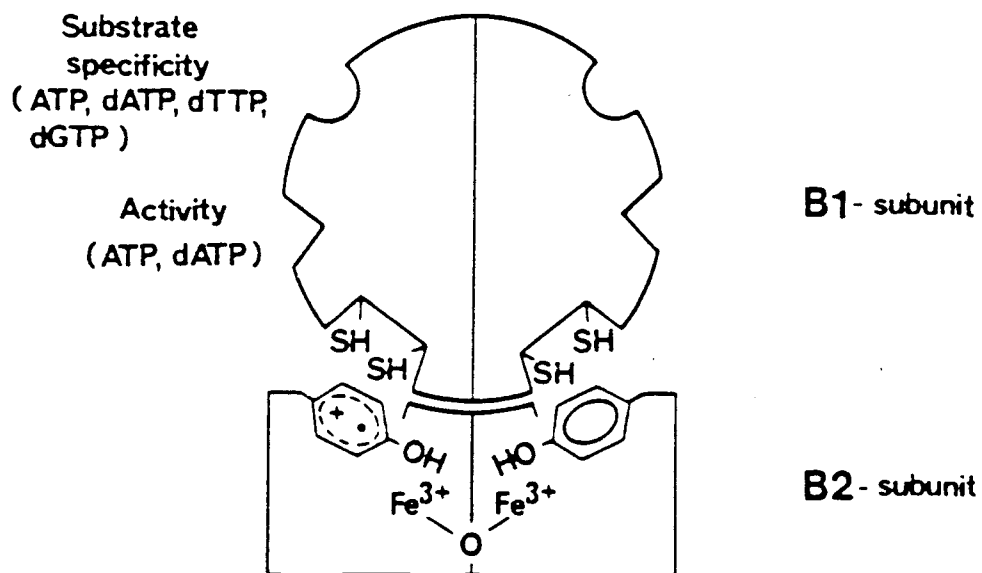

Figure 1. Schematic model of ribonucleotide reductase from E. coli. (Eriksson, S. and Sjöberg, B.-M., 1988, in press).

Crystals of the B2 subunits have been obtained, and some of the early successes of the X-ray crystallography of the E. coli RDPR have been published (Joelson, T., Uhlin, U., Eklund, H., Sjöberg, B.-M., Hahne, S., Karlsson, M., 1984). In the absence of Mg^{2+} , the complex of B1 and B2

subunits spontaneously dissociates. Upon reintroduction of Mg^{2+} , the enzyme structure is restored and the enzyme is catalytically active once again. When the enzyme is exposed to air, the RDPR is inactivated as well as caused to dissociate. Oxidation by air is reversed by reducing agents such as dithiothreitol, causing the enzyme to revert to its normal subunit structure and to regain its activity.

b. The T4 Bacteriophage RDPR

The T4 RDPR enzyme is similar in most respects to that of its E. coli host. The T4 enzyme possesses the same subunit structure, having two polypeptides each in the large subunit and the small subunit. The large subunit, labeled Nrd A, is 84,000 Da, and the small subunit, labeled Nrd B, is 43,000 Da. The Nrd A and Nrd B subunits have a much greater degree of cohesion than do their E. coli counterparts. Throughout purification of the T4 enzyme, and in conditions where no magnesium is present, the T4 RDPR subunits remain joined together. Functionally, also, T4 RDPR is very similar to the E. coli enzyme. The same four NDP substrates and the same triphosphate effectors are used as in E. coli with one notable exception. 5-Hydroxymethyl-dCTP, a substrate of DNA polymerase in T4-infected cells, also serves as positive effector for pyrimidine diphosphate reduction. The specific differences in allosteric and catalytic properties between T4 and E. coli will be covered below in a separate section. Genetically, T4 is again very similar to its host

cell, E. coli. Both in the E. coli and T4 genomes, the two genes for the subunits of RDPR reside adjacent to one another without duplication (Berglund, O., 1975). There is a remarkable difference in the genetic structure for the small subunit gene, however. In the T4 genome, there is an intron present in the gene for the small subunit.

c. The Mammalian RDPR

Mammalian RDPR enzymes differ from the E. coli model in several ways. First, the tyrosyl free radical is not a permanent fixture in the M2 subunit, but rather is formed transiently during the RDPR reaction. Also, hydroxyurea, which irreversibly destroys the free radical on the E. coli enzyme, reversibly inactivates the free radical on M2. The enzyme can be reactivated by removal of hydroxyurea on a Sephadex column (Engstrom, Y., Eriksson, S., Thelander, L., Akerman, M., 1979). Like the T4 RDPR enzyme, Mg^{2+} is not necessary for subunit association. Also, unlike E. coli and T4, most eucaryotic RDPR enzymes require an effector nucleotide, usually dATP, before aggregation of M2 subunits with M1 subunits will occur.

RDPR activity varies quite drastically depending on the phase of the cell cycle. Virtually no RDPR activity is seen during G1 phase, while a sharp peak of activity is seen during S phase. Much investigation has gone into where in the cell cycle the M1 and M2 subunits are synthesized such that S phase activity might be produced. Several reports have indicated that the subunits are not synthesized coordinately, i. e., that the transcription of the M1 and M2

subunits occurs at different times during the cell cycle. A number of different systems are currently being studied to approach this question. The groups of D. W. Martin, Jr. and Lars Thelander have reported that the concentration of the M1 subunit is constant throughout the cell cycle, while the M2 subunit is synthesized only at the beginning of S phase and has a much shorter half-life than does the M1 subunit (Eriksson, S. and Martin, D. W., Jr., 1981; Eriksson, S., Graslund, A., Skog, S., Thelander, L., and Tribukait, B., 1985). In contrast, the group of T. Youdale has reported that M2 subunit levels are high throughout the cell cycle and that the M1 subunit is in limiting supply, being synthesized in greater supply just before S phase (Youdale, T., Whitfield, J. F., Rixon, R. H., 1985). Alternatively, Albert and Gudas have published that the activity levels of the enzyme are regulated during the cell cycle by its own allosteric nature, and that the levels of the subunits are not responsible (Albert, D. A. and Gudas, L. J., 1985). Now that the mouse M1 and M2 genes are cloned (Caras, I. W., Levinson, B. B., Fabry, M., Williams, S. R., Martin, D. W., 1985; Thelander, L. and Berg, P., 1986), investigations of the molecular mechanisms of cell cycle control should be possible and resolution of these questions should be near.

2. B12-Requiring RDPR Enzymes

The adenosylcobalamine-requiring enzymes are the simplest RDPR enzymes known. A typical enzyme has a size of 76 kDa, consists of a

single polypeptide, and requires cobalt for the coenzyme. Ca^{2+} , Mg^{2+} , or Mn^{2+} may also be used to aid in catalyzing reduction. Nucleoside triphosphates serve as substrates in every AdoCbo-requiring RDPR reaction known (Hogenkamp, H. P. C. and Sando, G. N., 1974). A transient AdoCbo free radical functions during catalysis, the mechanism of which appears to be quite similar to Fe^{3+} -requiring enzymes (Babior, B. M., 1975). The AdoCbo-requiring

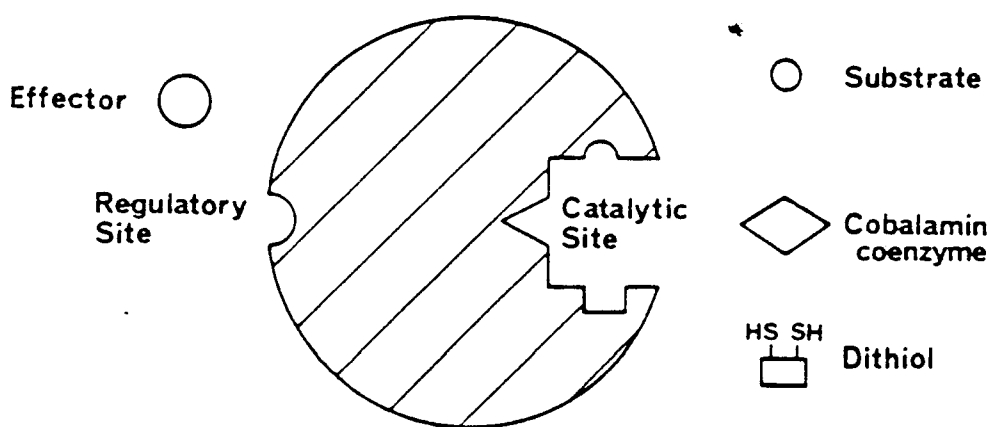

Figure 2. Schematic model of the single-subunit ribonucleotide reductase from Lactobacillus leichmannii (Eriksson, S. and Sjoberg, B.-M., 1988, in press).

enzymes form a disparate class. Some AdoCbo enzymes are known to require temperatures of 70°C for maximal activity (Sando, G. N. and Hogenkamp, H. P. C., 1973). And while some enzymes are single polypeptides of 80 kDa or less, some possess a molecular mass of more than 500,000.

3. Manganese-Requiring RDPR Enzymes

The least studied and one of the more unusual RDPR enzymes is the manganese-dependent RDPR. These enzymes, which have only recently been discovered, are found in certain gram-positive bacteria (Schimpff-Weiland, G., Follmann, H., Auling, G., 1981). Although rNTP's are known to be substrates, very little is known of the catalytic properties or allosteric requirements of this enzyme. Since hydroxyurea effectively inhibits Mn^{2+} -requiring RDPR enzymes, however, it has been postulated that Mn^{2+} is the counterpart of iron in Fe^{3+} -requiring enzymes. Cyanide has also been found to inhibit the enzyme, presumably by forming cyano complexes with Mn^{2+} . When the bacterial cells are cultured, Mn^{2+} starvation has been shown to lead to cessation of DNA synthesis. Continued study of the role of RR in the life cycle of these cells and of its mode of catalysis utilizing Mn^{2+} will lead to greater understanding of this complicated enzyme and the complicated reaction it catalyzes.

4. Viral RDPR Enzymes

One of the most important areas of RDPR research is in the field of viral RDPR's. In some viral systems, the RDPR enzyme itself is considered to be the transforming factor (Huszar, D., Bacchetti, S., 1983). Much research into synthesis of inhibitors has been initiated with the hope of destroying virus replication by destroying viral RDPR activity (Ator, M. A., Stubbe, J., Spector, T., 1986). Destruction of

viral RDPR activity must be preceded, however, by an ability to differentiate between the host cell RDPR and virus RDPR. To date, only three virus RDPR enzyme systems have been shown to be substantially different from the host RDPR: (1) T4 bacteriophage, (2) the herpesvirus, and (3) vaccinia virus (Slabaugh, M. B., Mathews, C. K., 1984). Much effort, however, has been applied to a number of other viral systems in the search for significant differences between host and virus ribonucleotide reduction. One of the most promising experimental approaches in the search for utilizable differences between virus and host RDPR enzymology has been published by the group of Lars Thelander (Lankinen, J., Graslund, A., Thelander, L., 1982). Thelander and his colleagues have developed an antibody against RDPR which completely neutralizes the activity of RDPR inside mouse L cells. In experiments, he has infected the cells with pseudorabies virus--a virus which induces its own RDPR. It was found that the viral RDPR was not inactivated by the anti-RDPR antibody and was assayable using an RDPR assay. The virus RDPR exhibited its own ESR signal, characteristic of its own free radical structure and different from the M2 ESR of mouse L cells. Thelander has elegantly succeeded in developing a system by which one can not only probe for differences between host and virus enzyme, but one in which one can study the nature of a virus enzyme without the competing activity of a host enzyme.

C. Allosteric Control

1. Specificity and Activity Sites

The enzymology of RDPR is fairly complicated. Most RDPR enzymes are both positively and negatively allosterically regulated. Allosteric regulation takes place in the large subunit of RDPR. There are two sites for allosteric regulation in RDPR enzymes of the E. coli type, the specificity site and the activity site, both located on the large subunit. These two types of allosteric site are defined by the affinity each has for dATP. The specificity site has a high affinity for dATP, while the activity site has a low affinity for dATP. The specificity site also binds effectors ATP, dTTP, dGTP, while activity sites bind only dATP and ATP. In a cell it is possible to have a situation, perhaps a genetic alteration in dNTP biosynthesis, where the pools of individual deoxynucleoside triphosphates (dNTPs) at the replication fork are widely different in concentration from one another. This difference could lead to errors in replication fidelity and to mutations in the nascent DNA. It has been shown that the availability of dNTPs directly affects the accuracy with which the DNA template is copied (Hibner, U. and Alberts, B., 1980).

Allosteric specificity sites and activity sites on the RDPR enzyme are designed to maintain replication fidelity by insuring that each deoxynucleotide is delivered to the replication fork in the proper concentration. When one dNTP increases in concentration substantially, this dNTP will stimulate the RDPR enzyme to reduce a particular nucleoside diphosphate (Larsson, A. and Reichard, P., 1966).

The binding of the dNTP by the large subunit causes increased affinity of the RDPR for a particular substrate--an actual conformational change at the active site which leads to a decreased K_m and increased K_{cat} for the particular substrate (von Döbeln, U. and Reichard, P., 1976). The magnitude of the allosteric effect is different at different substrate concentrations. At low substrate concentrations, it is possible to achieve a 50 to 100-fold stimulation of the RDPR reaction. The effect is much less at higher substrate concentrations.

2. Allosteric Regulation: T4 and E. coli

Let us examine the allosteric control of bacteriophage T4 and the bacterium, E. coli which it infects. The allosteric activity of these enzymes has much in common (Berglund, O., 1972; Larsson, A. and Reichard, P., 1966). In terms of the specificity site, the NDP substrates which are reduced in response to activation by dNTPs and ATP are virtually the same. ATP and dATP (at low concentrations) in both cases function as stimulators of pyrimidine reduction, i.e., for reduction of CDP and UDP. When the activity site is not filled by dATP or ATP, dTTP stimulates the reduction of GDP in both E. coli and T4. ADP is reduced best under conditions when dGTP is present in the specificity sites. GDP reduction occurs at the highest rate when dTTP is the deoxynucleotide present in the specificity sites of E. coli and T4. Linking this reduction of NDPs to production of dNTPs and the utilization of dNTPs in DNA synthesis one can achieve the following

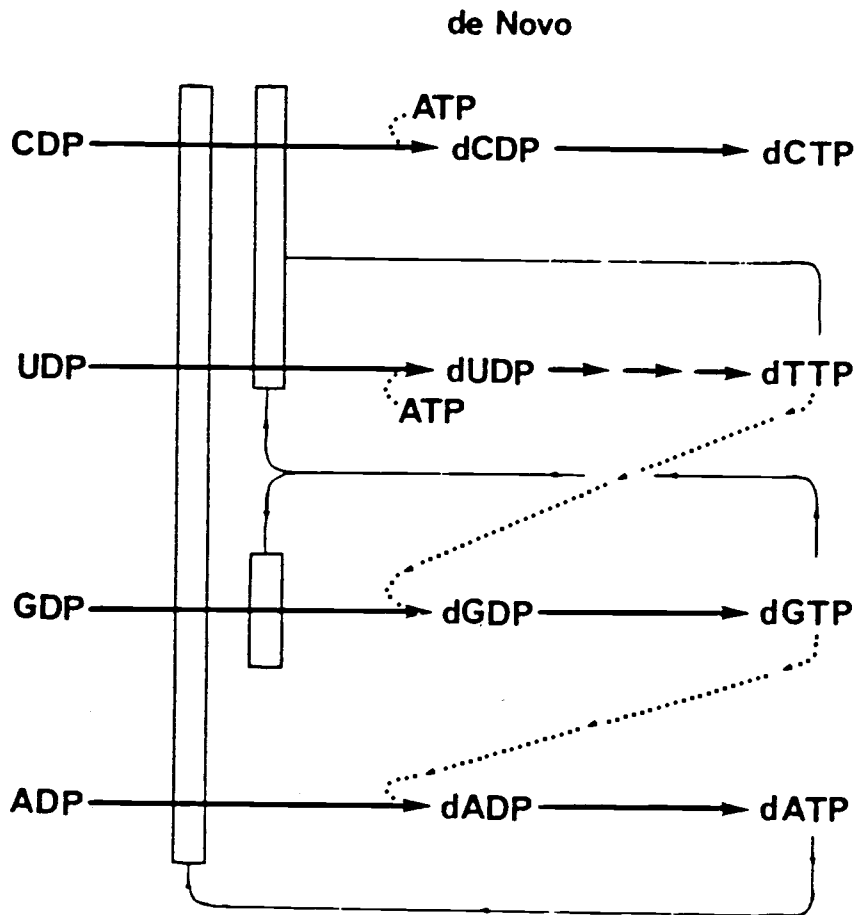

Figure 3. Schematic model of the regulation of deoxyribonucleoside triphosphate biosynthesis in *E. coli*. Feed-back inhibition is denoted by solid lines ending in open rectangular boxes and allosteric activation is denoted by dashed lines (Thelander, L. and Reichard, P., 1979).

(see figure): dNTP generation begins with CDP and UDP reduction by an RDPR enzyme which is activated by having ATP in the specificity site; following the build-up of pyrimidine dNTPs, dTTP binds to the specificity site of RR and GDP reduction is stimulated; finally, when levels of dGTP rise, dGTP binds to the enzyme specificity site and ADP reduction is stimulated. Although this scheme is a simplification of what occurs in most cells, in outline it contains

features which characterize ribonucleotide reduction in most procaryotic and eucaryotic systems.

Although there are few differences with respect to specificity sites, there are major differences in the activity sites between E. coli and T4. In E. coli, ATP activates NDP reduction, while dATP deactivates NDP reduction. In T4, ATP activates NDP reduction, but dATP does not have a negative effect on NDP reduction (Berglund, O., 1975). The reason is quite sensible when one examines the lifestyle differences between E. coli and T4. As a cellular organism, E. coli must respond metabolically to changes in its environment. Under varying conditions, E. coli must react by synthesizing and activating the proper machinery. Homeostasis, maintaining a balanced metabolism, is the life of an E. coli cell. The existence of the T4 virus is in complete contrast to that of its host. Upon injection of T4 DNA into E. coli, the start of "life" for T4 is the start of a 20 minute race during which DNA metabolism runs at full speed. The RDPR enzyme is always "on". No feedback inhibition or negative allosteric control exists to slow the enzyme down.

D. Hydrogen Donor System

There are other differences in the reduction of nucleotide diphosphates by T4 and E. coli. Reduction of an oxidized disulfide on the RDPR large subunit after reduction of the ribose moiety on the substrate is necessary for the regeneration of the enzyme. A small protein disulfide oxido-reductase called thioredoxin is necessary for

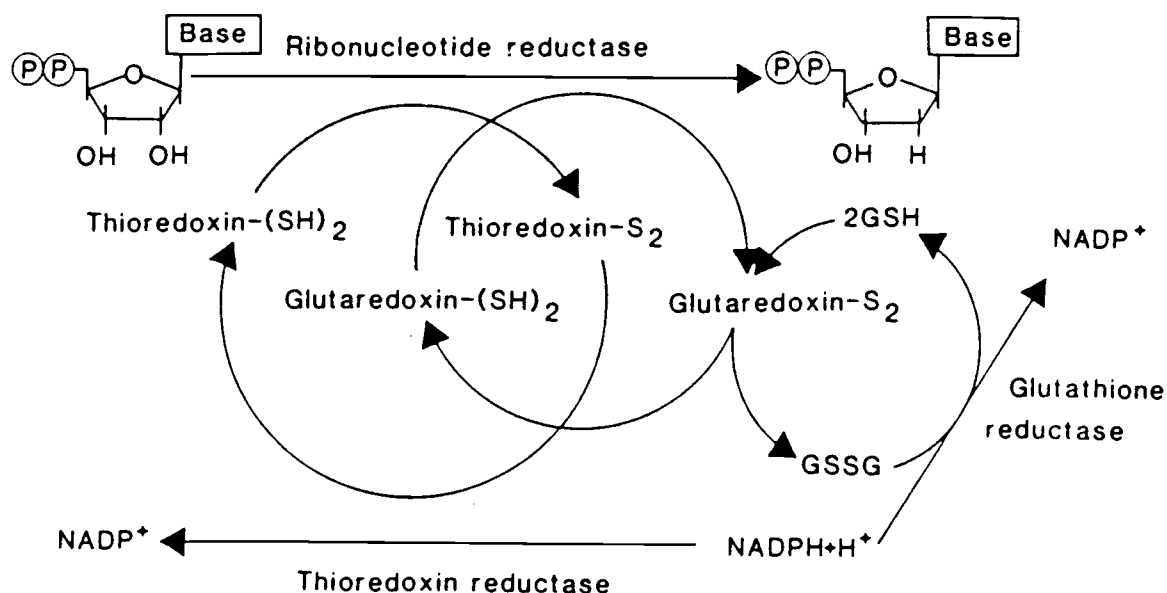

Figure 4. Components involved in the electron transfer from NADPH to ribonucleoside diphosphates (Holmgren, A., 1978; Holmgren, A., 1985).

the regeneration of RDPR back to active form (Holmgren, A., 1981). Although the active sites of the thioredoxins of both *E. coli* and T4 are similar, neither will substitute for the other in the regeneration of *E. coli* and T4 RDPR enzymes (Holmgren, A., 1985). The structures of several thioredoxins have been determined by X-ray crystallography and all appear to share the same general domains, yet they are generally not exchangeable in reductions between RDPR's from different species (Soderberg, B. O., Sjoberg, B.-M., Sonnerstam, U., Branden, C.-I., 1978). Regenerating oxidized thioredoxin in *E. coli* is the function of a specific NADPH-utilizing protein called thioredoxin reductase. In *E. coli*, there is an additional system available for reducing RDPR. The small protein involved is called glutaredoxin and

the enzyme by which it is regenerated is a glutathione-utilizing enzyme called glutaredoxin reductase (Holmgren, A., 1979). Unlike thioredoxin from E. coli, glutaredoxin is capable of reducing RDPR enzymes from E. coli as well as T4. And although E. coli thioredoxin cannot be reduced by glutaredoxin reductase, T4 thioredoxin can be reduced by glutaredoxin reductase. Glutaredoxin reductase, in fact, is the only enzyme capable of reducing T4 thioredoxin in T4 infected cells. Interestingly, glutaredoxin from E. coli is capable of reducing oxidized T4 RDPR, as well as oxidized E. coli RDPR.

E. Reaction Mechanism

The complete mechanism of the RDPR reaction has yet to be determined in its entirety. The current techniques being used to study the mechanism are experiments with azido- and halogenated substrate inhibitors (Ator, M. and Stubbe, J., 1985; Sjoberg, B.-M., Graslund, A. and Eckstein, F., 1983) and experiments using nuclear magnetic resonance, Raman, and electron paramagnetic resonance spectrophotometry (Sahlin, M., Ehrenberg, A., Graslund, A., Sjoberg, B.-M., 1986). To begin, I will lay out the structural elements involved in the active site. First and most important, the E. coli and T4 RDPR enzymes possess a single tyrosyl free radical on one of the two polypeptide chains of the B2 subunit. RDPR enzymes are unique among proteins in having a free radical as an integral part of their protein structure and active site. Also present on enzymatically active B2

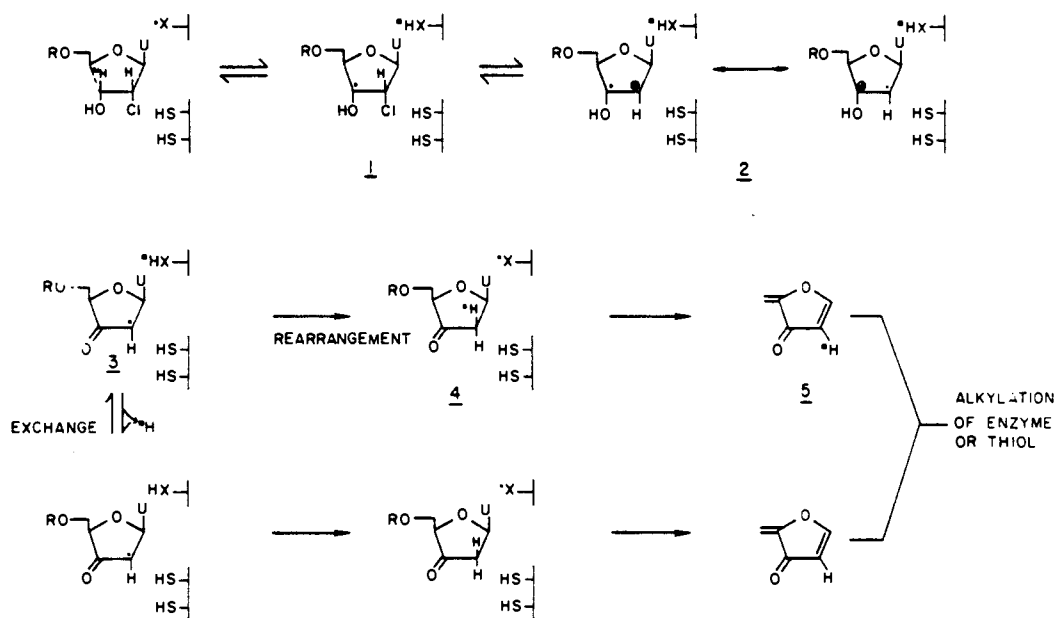

Figure 5. Proposed mechanism of inactivation of ribonucleotide reductase by 2'-Chloro-2'-deoxyuridine 5'-diphosphate. "X" represents the tyrosyl radical on the small subunit (Ator, M. A. and Stubbe, J., 1985).

subunits are two iron atoms in an Fe^{3+} oxidation state. These iron atoms are linked by an oxygen molecule in an antiferromagnetic coupling by a μ -oxo bridge. The iron atoms function in catalysis to stabilize the free radical on the tyrosine residue. Also present at the active site are two sulfhydryl residues contributed from cysteines on the B1 subunit (Sjoberg, B.-M., Karlsson, M., Jornvall, H., 1987). Thus the active site possesses amino acid residues from both subunits B1 and B2 and exists at the interface between the two subunits.

It is now believed that the RDPR mechanism proceeds via a radical cation substrate intermediate (Sjoberg, B.-M., Graslund, A., Eckstein, F., 1983; Ator, M. A. and Stubbe, J. 1985; Sjoberg, B.-M., Karlsson, M., Jornvall, H., 1987). Most of the reaction steps have been

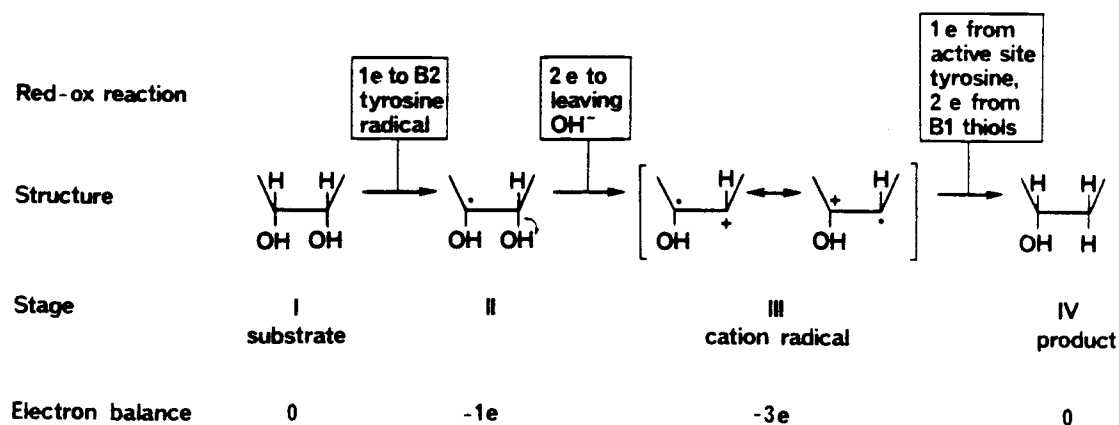

Figure 6. Proposed reaction mechanism for ribonucleotide reductase from *E. coli* (Sjoberg, B.-M., Graslund, A., Eckstein, F., 1983).

worked out using substituted substrates, and it is difficult to say in which part of the mechanism there is direct application to reactions using non-substituted substrates. The reaction begins with removal of the 3'-hydrogen of the ribose by the tyrosyl radical of the B2 subunit. This generates a radical at the 3' position of the ribose (Ator, M. A. and Stubbe, J. 1985). The tyrosyl moiety is believed to serve as an intermediary for the hydrogen during the reaction. While the hydrogen transfer is occurring, the 2'-hydroxyl is abstracted by a condensation step resulting in a cation at the 2' position, and a radical substrate cation intermediate is generated. The dithiol residues of the B1 subunit then donate two electrons to the reaction intermediate, the tyrosyl residue gives back its hydrogen, and a deoxynucleotide product is created. As a last step, the sulfhydryls on

the B1 subunit are reduced by thioredoxin or glutaredoxin, making NADPH the ultimate hydrogen donor, and the enzyme is regenerated and ready for another reduction.

Much more is known about the mechanism of RDPR using substrate analogues as reactants than using normal substrates. Gradually, as knowledge of the chemistry of the functional groups accumulates, more detailed predictions of the nature of RDPR enzymes will become possible. The mechanism, to the degree that it is worked out, appears to be the same between T4 phage enzymes, E. coli, and mammalian enzymes (Sjoberg, B.-M., Graslund, A., Eckstein, F., 1983). Striking differences between herpes simplex virus 1 and the E. coli model exist, however (Ator, M. A. and Stubbe, J., 1985; Spector, T. and Jones, T. E., 1985).

F. RDPR as Member of Enzyme Aggregate

There have been several published accounts over the past 15 years proposing that the RDPR enzyme is a participant in a complex of enzymes whose function is to produce as an end product, DNA. The purpose of the complex is to channel DNA precursors such that a concentration gradient with high concentrations of dNTP's at the replication fork is formed. Two functions of the enzyme complex are to (1) enhance the overall synthesis rate of DNA, and (2) to provide the replication fork with pools of nucleotides having proportions necessary for the mutation-free synthesis of DNA (Mathews, C. K., and Sinha, N. K., 1982). The fact that a concentration gradient is formed

by the complex necessitates the establishment within the cell of 2 pools of deoxynucleotides. The first pool should contain in high concentration proportional amounts of all four dNTP's to the composition of bases in the DNA. Unfortunately, this pool is probably not quantifiable using current technology. The second pool contains the commonly measurable intracellular dNTP's which fluctuate during the cell cycle and which serve in DNA repair as well as allosteric effectors for RDPR (Nordenskjold, B. A., Skoog, L., Brown, N. C., Reichard, P., 1970).

dNTP-metabolizing enzyme complexes have been shown to be aggregations of proteins which have delicate attachments for each other and are not commonly purifiable using classical protein purification techniques (Allen, J. R., Reddy, G. P. V., Lasser, G. W., Mathews, C. K., 1980; Chiu, C.-S., Cook, K. S., Greenberg, G. R., 1982). They do not approach the well-defined composition of the complexes of fatty acid synthase or pyruvate dehydrogenase. Extremely gentle methods must be used if one attempts their purification or to probe their structure. RDPR has been reported to be a part of several multi-enzyme complexes. Complexes from T4-infected E. coli, uninfected E. coli, rat liver, calf thymus, and from a number of cultured cell lines have been reported to contain RDPR (Lunn, C. A., Pigiet, V., 1979; Noguchi, H., Reddy, G. P. V., Pardee, A. B., 1983; Wickremasinghe, R. G., Yaxley, J. C., Hoffbrand, A. V., 1982).

G. T4 Bacteriophage Introns

The three introns which occur in T-even phages are the only introns known to exist in any prokaryotic system. Comparing the three introns in T4 with introns in certain eucaryotic genes is a valuable exercise. It demonstrates the high degree of genetic sophistication occurring in T4, part of which apparently involves the acquisition of genetic material from higher organisms. The three genes having introns in T4 are: (1) nrd B, the gene coding for the small subunit of RDPR in T4; (2) td, a gene coding for T4 thymidylate synthase; (3) sun_Y, an unidentified--yet functional--open reading frame (Shub, D. A., Gott, J. M., Xu, M.-Q., Lang., B. F., Michel, F., Tomaschewski, J., Pedersen-Lane, J., Belfort, M., 1988; Gott, J. M., Shub, D. A., Belfort, M., 1986). The three introns are found to be very closely related. All the introns can be excised in the absence of protein factors; during excision, each makes the addition of a noncoding G at the 5' end; splicing occurs after a U at the end of exon 1 and after a G at the 3' end of the intron; there is extensive secondary structure in the three introns. All these criteria place the three T4 introns in a class greatly similar to group 1A introns of eucaryotes (Shub et. al.,1988). Group 1A intron splicing is characterized by the self-splicing introns in the ribosomal genes of *Chlamydomonas* and *Tetrahymena*. The core structure of complementary base-pairing and stem-loop structures of group 1A introns bears remarkable resemblance to the core secondary structures of the three T4 introns. The four conserved sequences of

group 1A introns: P, Q, R, and S, demonstrate extensive homology with the three T4 intron sequences.

Also similar to many group 1 introns, all the T4 introns contain open reading frames (ORFs) (Belfort, M., Pedersen-Lane, J., Ehrenman, K., Chu, F. K., Maley, G. F., Maley, F., McPheeters, D. S., Gold, L., 1986; Sjöberg, B.-M., Hahne, S., Mathews, C. Z., Mathews, C. K., Rand, K. N., Gait, M. J., 1986). Each of the T4 intron ORFs have the appearance of being functional *in vivo*. The ORFs are all preceded by a sequence characteristic of T4 late promoters. The size and protein sequence of the nrd B intron ORF, however, diverges widely from that of the ORFs of td or sun_Y. The nrd B ORF amino acid sequence is short and contains two repeated domains which are thought to be representative of a divalent metal-binding peptide. The td and sun_Y ORF peptide sequences are much longer, and more basic proteins than that of the nrd B ORF and appear to be nucleic acid-binding proteins.

There is still no widely accepted model of gene regulation which accounts for the presence or necessity of introns in T4 genes. It is possible, however, that the introns have a negative regulatory role in the expression of the T4 genes. At least two of the genes, td and nrd B, express proteins which are non-essential for phage growth and should be dispensable under high stress, low nutrient conditions. The similarity between the T4 and group 1A introns of eucaryotes is remarkable. It is impossible to say at this stage, however, from which genetic direction the gene transfer responsible for the presence of introns in T4 occurred, or for what purpose they are present in the T4 genome.

H. Cloning and Sequencing T4 RDPR

nrd A and nrd B both have been sequenced as of this writing (Sjoberg, et. al., 1986; and G. R. Greenberg, personal communication). The nrd B gene was sequenced recently and found to reside much farther downstream, closer to den A and gene 63, than expected. nrd A has recently been sequenced by Robert Greenberg's group. From this definitive positioning of both genes a gap of 1.5 kb is found to exist between the end of the nrd A gene and the beginning of exon 1 of nrd B (Chu, et. al., 1987).

The nrd A gene was cloned several years ago by Mileham et. al. (1980), as part of an endeavor to construct a Hind III library of T4 phage clones in the T4 region between frd and the gene for DNA ligase. This is the only published account of the cloning of nrd A in the literature. In this experiment, T4 cytosine-containing DNA digested with Hind III was cloned behind the P_L promoter into lambda vectors. The vectors possessed temperature-sensitive lambda repressor genes and could therefore be induced by temperature to express genes present on the cloned DNA. A protein product of 83 kDa was found in extracts from clones containing the 5.2-kb Hind III fragment which is located between map units 137.6 and 142.8 of the T4 map. This polypeptide appeared to be the large subunit of RDPR. To confirm that the lambda clone expressed nrd A, ³⁵S-labelled extracts were made from the clone, from wt T4 infections, and also from extracts of infections from a T4 deletion mutant known to be missing nrd A. On SDS gels of the ³⁵S-labelled polypeptides they demonstrated that the

cloned peptide corresponded to the nrd A gene product. Neither these researchers or others working with nrd A-lambda clones were ever able to purify the large subunit in quantity (personal communication). Although it was demonstrated that the nrd A gene was present on the 5.2-kb Hind III fragment, Mileham et. al. were not able to clone the nrd B gene or localize it on the T4 map. Since the nrd B gene has yet to be cloned by any research group, this lack of success may reflect the unclonability of the nrd B gene.

I. Clonability/Unclonability

One of the original papers to describe cloning in T4 was that of Wilson, Tanyashin and Murray (1977). One of the developments of Wilson et. al., was the demonstration of fragments around the T4 restriction map for which cloning is possible. A second major development was their demonstration of fragments which are not clonable. Researchers were placed on notice that not every piece of T4 DNA was necessarily clonable. Unclonable fragments could exist because the gene products themselves are lethal to E. coli or because a promoter or genetic regulatory element is lethal.

An aura of mystery surrounds the unclonability of genes of T4. No certain factor explains every case in which unclonability is a problem. Indeed, the reasons sometimes given for unclonability tend heavily towards speculation. Some fragments are found to be unclonable, only to have all their subfragments be quite easily clonable. Alternatively, some fragments one may attempt to clone only to find that only

pieces of the original fragment actually get cloned. The only true method of determining the clonability of a fragment is to attempt its cloning.

J. Purpose of Current Work

Our original purpose with this work was to achieve a clone which contained the nrd A and nrd B genes of T4. With this clone it was hoped to achieve overexpression of the large and small subunits of RDPR. Having the cloned genes in hand, it was thought that their sequencing would be useful for purposes of comparison with other organisms. The genes for the large subunit of RDPR of E. coli, mouse, herpesvirus, and vaccinia virus have already been sequenced at this time (Caras, I. W., Levinson, B. B., Fabry, M., Williams, S. R., Martin Jr., D. W., 1985; Tengelsen, L. A., Slabaugh, M. B., Bibler, J. K., Hruby, D. E., 1988). Of particular interest would be the possible differences between T4 and E. coli in light of the lack of negative allosteric behavior in T4. Additionally, previous work in our lab has shown that expression of enzymes from overexpression vectors is extremely useful when purification of an enzyme is difficult. The purified proteins could be used for antibody production, enzyme-bonded columns, and for use in crystal production for x-ray diffraction.

MATERIALS AND METHODS

A. Enzymes for Cloning

Much of the work involved in this thesis revolves around manipulation of DNA. And most of the techniques involving DNA can be found in the latest edition of Molecular Cloning by T. Maniatis. I have made some modifications to certain techniques, and these modifications I will elaborate upon.

Cloning work uses a variety of enzymes requiring highly specialized chemical and physical conditions. The work in this thesis adhered as closely as possible to all the specifications given by the manufacturer.

Restriction enzyme digests were conducted according to manufacturer's specifications (BRL, New England Biolabs, Pharmacia) with the following exception. Quantity of enzyme to be used is always increased by a factor of five. The predominant reason was that volumes recommended by the manufacturer were too small to aliquot without dilution and the difference in price was ultimately negligible.

Bacterial alkaline phosphatase (BAP) was the enzyme used to remove 5'-terminal phosphates from the ends of DNA fragments or vectors when it is desired that these ends be ligated to a different fragment. This reaction was typically carried out at 68°C for 1 hour in TE buffer. It is essential to remove BAP after it has been used, as this will prevent subsequent ligation. BAP removal was accomplished

by using at least 3 phenol extractions.

The Klenow fragment of E. coli DNA polymerase I was the enzyme used to make 3' overhangs blunt. The enzyme worked by filling in bases required to blunt DNA ends. The reaction mix contained quantities of all four deoxyribonucleoside triphosphates and was constructed according to Maniatis standards. The reaction proceeded for 2 hours before stopping. The blunt-ending reaction was needed before ligations with Sma I and Hpa I restriction enzyme-cut ends could be completed.

T4 DNA ligase was essential to joining DNA ends before transformations. Ligase has specialized reaction requirements which were followed closely. Also, any ammonium in the reaction will stop the reaction. For sticky-end ligations, there was always a six-fold greater quantity of insert compared to quantity of vector. For blunt-end ligations there was always maintained a ten-fold excess of insert over vector. Blunt-end ligations are still fairly problematic, however, and it was very common when a blunt-end ligation failed. Both types of ligations are incubated at around 13°C for 12-24 hours before being added to transformation reactions. Both DNA insert and vector were phenol extracted and ethanol precipitated before ligation.

B. Preparation of T4 C-DNA and Plasmid DNA

Bacteriophage strain T4 GT-7 and host cells E. coli B834 were obtained from Dr. Betty Kutter, Evergreen State University, and were used as described in Wilson et. al., 1977, for the making of T4 DNA

which did not contain glucosylated hydroxymethylated cytosine residues. T4 wt strains possess glucosylated hydroxymethyl cytosine (HMC) as a replacement for cytosine as a defense against host nucleases. Using a multiple mutant strain of T4, in which the genes for hydroxymethylase, dCTPase, endonuclease A, and alc (stands for allows late transcription on C) have amber lesions, one can achieve cytosine-DNA.

To grow 1 liter GT-7 infected cells, E. coli B834 was grown to 0.2 A₆₀₀ and infected at 0.1 moi with GT-7. After 6 hours, chloroform was added, 20 ml sterile saturated MgSO₄, 100 µl DNase I (10 mg/ml), 300 µl RNase (1 mg/ml) added. After 12 hours at room temperature, the cell debris was pelleted out, and the GT-7-containing supernatant was decanted into GSA buckets and centrifuged using the GSA rotor for 30 minutes at 9,000 rpm. After decanting the supernatants, the GT-7 phage pellets were resuspended with 60 ml M9 buffer and recentrifuged on the Ti40 rotor at 25,000 rpm in the ultracentrifuge. The pelleted phage were resuspended with 30 ml M9 buffer. The suspended phage particles were then phenol extracted twice, followed by a chloroform extraction. Finally, the de-proteinized GT-7 DNA was ethanol precipitated.

Mini-preps of plasmid-containing cultures were conducted as per Maniatis' directions for Boiling Style Rapid Small Scale Isolation of Plasmid DNA, without modification.

Large preps of plasmid DNA were usually prepared identical to the Lysis by Alkali method by Maniatis with one exception. In these

experiments, the first centrifugation was done in a Sorvall GSA rotor at 9,000 rpm for 15 minutes rather than a Beckman SW 27 rotor at 20,000 rpm for 20 minutes. The supernatant from the first centrifugation was treated the same as in Molecular Cloning. In the very early plasmid preps, cells were harvested and lysed according to the boiling prep protocol used for lysing cells for mini-preps. All the solutions used in the protocol were scaled-up to handle the volume of cells to be harvested. The first centrifugation of the extracted cells took place in Corex 30-ml tubes in SS-34 rotor at 14,000 rpm.

The cesium chloride gradient technique was changed somewhat from that outlined in Molecular Cloning. The DNA samples were ethanol precipitated, resuspended with 8 ml TE buffer (a multi-purpose buffer constructed of 50 mM Tris, pH 8, and 1 mM EDTA), mixed with 8g CsCl, and added with 0.8 ml 10 mg/ml ethidium bromide. The remainder of the protocol is essentially the same as that outlined in Molecular Cloning. The use of cesium chloride gradients to purify plasmids was fairly routine albeit not always used in the thesis work. In some cases, the plasmid was clean enough following the plasmid prep to be used in following steps.

C. Purification of DNA Fragments

Purification of DNA fragments was accomplished with a technique using DEAE paper or by electroelution. The earlier used DEAE paper technique was similar to that found in Molecular Cloning.

A slit is made in the gel just in front of the migrating DNA band and a small piece of DEAE paper is inserted. The current is restored to the gel and the DNA band is allowed to migrate completely onto the piece of DEAE paper. After the current is turned off, the strip of DEAE paper is removed and placed in a plastic vial with 0.6 M NaCl, 50 mM Tris pH 8, 1 mM EDTA. After vortexing and centrifuging, the solution was ethanol precipitated. The purified fragment was always tested by agarose minigel electrophoresis before use.

The second technique used for DNA fragment collection was electroelution. Electroelution is a technique whereby DNA is drawn out of agarose gels by electrical current. Fragments of agarose containing DNA were cut from agarose slab gels and placed in dialysis bags with approximately 1.5 ml 0.5x TBE. The dialysis bags were clamped closed and were placed in an apparatus specially constructed for electroelution. Given the current needed for electroelution, the apparatus needed a cooling system. A thermostatic cooling bath pumping cold ethylene glycol through the electroelution chamber was connected. The electroelution chamber was filled with 0.5x TBE to a level just above the DNA-containing agarose gel fragments. Current was kept at 100 volts or below to prevent the build-up of excessive heat. Electroelution length varied between 3 and 5 hours depending on the size of the DNA fragment. Short DNA fragments could be electroeluted in 3 hours or less. Following electroelution, the eluate was collected into small plastic vials and ethanol precipitated. Before use, the DNA fragment was phenol extracted and re-precipitated.

D. DNA Gels

Large agarose gels were poured as per Maniatis specifications in Molecular Cloning. Agarose mini-gels required somewhat more attention but were not difficult. The glass lantern slides forming the sandwich of the minigel were sealed into the plexi-glass upper unit using 1% agarose. Before agarose was pipetted between the plates, the unit was suspended above a 60°C water bath. After being brought to temperature, agarose in 1X TAE was pipetted between the plates. The unit, complete with agarose-filled plates was placed at room temperature until solidification. After the unit is set up with buffer and the plates have solidified, the comb is removed and the gel is ready for electrophoresis. Agarose minigels were appropriate to separate DNA fragment lengths between 12 kb down to 1 kb.

Polyacrylamide gels for DNA analysis were constructed as in Molecular Cloning. Acrylamide DNA gels were never larger than mini-gels. For examining DNA of the lengths between 1 kb and 300 bp a gel of 3.5% acrylamide was most appropriate. Below 3.5%, acrylamide gels became somewhat difficult to work with. 1X TBE was the buffer used for all nucleic acid polyacrylamide gels.

E. DNA Sequencing

Sequencing protocols and methods were taken mostly from the Pharmacia Manual for Sequencing which comes with their sequencing

kit. The kit provided all dideoxynucleotides and deoxynucleotides, the Klenow fragment DNA polymerase I and M13 ssDNA primer. The sequencing gel was a 6% acrylamide buffer gradient gel. TBE buffer concentration was 0.5X at the top of the gel and 5X at the bottom of the gel. The sequencing gels were easy to pour except for removing the bubbles trapped between the plates. The bubbles usually could be encouraged to float to the top if the gel plates were tapped energetically with a hammer.

After some trial and error, it was found that gels which were polymerized using 0.05% ammonium persulfate and 0.00077% TEMED polymerized in about 20 minutes. 20 minutes leaves ample time to pour and remove bubbles before the gel polymerizes. Following polymerization, buffer tanks were set up, the comb was pulled out of the gel and the wells were cleaned of urea and extraneous gel material.

Using the sequencing kit, the sequencing reactions were quite easy to set up and perform. The Pharmacia reaction protocols, with slight modifications, were those used in all the reactions. It was found that the most important factor in the reactions was the competition between the deoxy and the dideoxy nucleotides. If the dideoxynucleotide concentration was too high, the bands at the top of the lane disappeared. The high dideoxy concentration quenched long DNA lengths. After the dideoxynucleotide concentration was decreased, bands appeared to the top of the gel in that lane. After much trial and error, the following dideoxynucleotide concentrations were found to produce a good spread of bands throughout the gel: 0.04

mM ddATP, 0.35 mM ddCTP, 0.3 mM ddGTP, 0.7 mM ddTTP. ^{35}S -dATP was used in all the DNA sequencing experiments. ^{35}S -dATP gave quite sharp bands with excellent readability.

F. Labeling of Plasmid-Coded Proteins

The labeling of plasmid proteins was carried out by a method published by Sancar, A., Hack, A. M. and Rupp, W. D., in 1979. The use of this method leads to the formation of maxi-cells. The essence of their technique was to UV-irradiate E. coli cells in early log phase, place the cells in minimal medium, and to incubate the cells in ^{35}S -methionine for 1 hour. The protocol of Sancar et. al., was followed fairly closely in this thesis . However, rather than running extracts on large slab gels, it was decided to use mini-gels.

G. 60 kDa Peptide: Cell Culturing and Assay for Ribonucleotide Reductase

Attempted protein purification of the peptide called the 60 kDa peptide expressed by the cells carrying the plasmid pKC 13, was the last operation carried out in this thesis work. Large quantities of this peptide were produced in cells grown in culture using a New Brunswick Fermenter. Media for a 10-liter fermenter receptacle consists of the following: 110 g tryptone, 225 g yeast extract, 200 g glucose, 0.100 M potassium phosphate (pH 7.5), 10 liters

double-distilled H₂O, 1 ml antifoam. Using this medium one could achieve yields of 40 g cell paste per liter of medium.

An effective assay procedure for ribonucleotide reductase was developed by Mary Slabaugh in our lab, and published in J. Virology, Nov. 1984, p. 507-514. The essentials of the procedure as it was used in experiments in this thesis will be outlined here. The 40 μ l reaction mix contained 100 mM HEPES (pH 7.8), 10mM DTT, 10 mM NaF, 20 μ M FeCl₃, 4 mM AMP-PNP, 2 mM magnesium acetate, 25 μ M (³H)CDP (100 to 200 cpm/pmol), and enzyme extract. The reaction mix was incubated 30 minutes, then 4.4 μ l 10 M perchloric acid was added, tubes centrifuged, and 40 μ l supernatant transferred to new tubes. 4 μ l marker solution and 5M KOH was added. The tubes were spun again to remove the large precipitate pellet, and then 20 μ l aliquots of the supernatant were spotted on cellulose thin-layer chromatograms to which a 15-cm 3MM paper wick had been attached. The chromatogram was developed in a solvent composed of ethanol-saturated sodium tetraborate-5 M ammonium acetate (pH9.8)-250 mM EDTA. After development, the chromatogram was visualized under UV light to determine dCMP-dUMP spots, and these were cut out and counted in a scintillation counter.

H. 60-kDa Peptide: Solubility Tests and Initial Purification

The 60-kDa peptide was found to be completely insoluble in aqueous solution. Many solvents and solutions were tested for

solubilizing activity on the 60-kDa peptide. A quarter of a gram of cell paste was mixed with the prospective solvent and sonicated. The extract was centrifuged on a bench-top centrifuge at 15,000 rpm for 5 minutes, and the supernatant was decanted into a second tube. The pellet was resuspended back to the original extract volume with the tested solvent, and 100- μ l samples of both the solubilized pellet as well as the supernatant were brought to 0.10 % SDS with 10% SDS. Aliquots of these samples were then heated to boiling and run on a 10 % PAGE gel against size standards. Solvents capable of solubilizing the 60-kDa peptide exhibited a dark heavy band at the 60-kDa position in the supernatant fraction. Solvents not able to solubilize the 60-kDa peptide exhibited a heavy band on the SDS polyacrylamide gel electrophoresis (PAGE) gels at the 60-kDa position in the pellet fraction. By using this technique, it was found that 6 M urea solubilizes the 60-kDa peptide.

A slight purification of the 60-kDa peptide was achieved by sonicating the E. coli pKC 13-containing cell pellet in aqueous solution, centrifuging, and then solubilizing the pellet (P1) in 6 M urea. The urea-solubilized pellet was then centrifuged, leaving cell debris in the pellet (P2), and the soluble 60-kDa peptide in the supernatant (S2). All of the protein extracts loaded on protein purification columns were S2 supernatants.

I. 60-kDa Peptide: Column Chromatography

Three types of ion-exchange matrices were used in the attempted

column purification of the 60-kDa peptide. These three were DEAE-, QAE-, and CM-Sephadex. The instructions for using these matrices were found in the Pharmacia book Ion-Exchange Chromatography, Principles and Methods. The columns used had the dimensions 1 cm x 30 cm. The DEAE bead type was A-25; the CM bead type was C-25, and the QAE bead type was A-50. The type 25 beads have much greater bead rigidity compared to type 50 beads, but have lower binding capacity. The equilibrating and the starting buffers for DEAE-; QAE-; and CM-sephadex chromatography were 10 mM potassium phosphate (pH 6.5), 6 M urea. The columns were packed overnight and run at 4 ml/hr. Samples were 1 ml in volume. One column volume starting buffer was first eluted followed by 100 ml gradients starting with the starting buffer and ending with 500 mM potassium phosphate (pH 6.5), 6 M urea. 5-ml fractions were collected. Selected fractions were assayed by SDS PAGE gels.

A second type of column chromatography used in the attempted purification of the 60-kDa peptide was gel filtration chromatography. Sephadex G-150 was the matrix type. A column 2 cm x 90 cm in size was used. The matrix was packed and run as per the directions in Gel Filtration, Theory and Practice, a Pharmacia publication. 0.10 M potassium phosphate (pH 6.5), 6 M urea was the running buffer. 3 ml extract was loaded for each run and a flow rate of 1 ml/min was maintained. 5-ml fractions were collected, and the A_{280} of the eluate was monitored on a Hitachi 100-80 spectrophotometer via a flow-cell. Selected fractions were assayed by SDS PAGE gels.

Hydroxyapatite column chromatography was also used in an

attempt to purify the 60-kDa peptide. The thesis of Thomas North, Ph. D., was used as a reference in the use of hydroxyapatite chromatography. Hydroxyapatite is a column material composed of calcium phosphate particles which is usually eluted using a phosphate buffer. The hydroxyapatite was always equilibrated the night before pouring with a buffer of 0.05 M potassium phosphate (pH 6.5), 6 M urea. A 2.5-cm x 25-cm column was used. 3 ml of extract was loaded on the column. Two types of gradient were used to elute the column. The type first used was a linear gradient from 0.05 M potassium phosphate (pH 6.5), 6 M urea, to 0.5 M potassium phosphate (pH 6.5), 6 M urea. The second gradient was a step gradient using the following four steps of potassium phosphate concentration: 0.05 M, 0.15 M, 0.25 M, 0.50 M. 5-ml fractions were collected. A_{280} was monitored on a Hitachi 100-80 as previously mentioned. Selected fractions were assayed using SDS PAGE gels.

Hydrophobic interaction chromatography on phenyl-Sepharose CL-4B was another type of chromatography used in the attempted purification of the 60-kDa peptide. It was thought that the hydrophobic matrix may interact with groups on the 60-kDa peptide which contribute to make the peptide insoluble in aqueous solutions. Experimental technique regarding the matrix was found in the Pharmacia publication Octyl-Sepharose CL-4B, Phenyl-Sepharose CL-4B For Hydrophobic Interaction Chromatography. Before pouring into the 1 cm x 30 cm column, the phenyl-sepharose CL-4B slurry was equilibrated several times with the starting buffer 0.010 M potassium phosphate (pH 6.5), 6 M urea, 0.5 M NaCl. After pouring and set-up, 1

ml extract was loaded onto the column, and the column was eluted with starting buffer for 80 mls. Afterward, the column was eluted with a 150-ml gradient of starting buffer to a buffer containing no NaCl. The column was ran at 10 ml/hour and 5 ml fractions were collected. Selected fractions were assayed using SDS PAGE gels.

RESULTS/DISCUSSION

A. Cloning the 5.2 kb Hind III Fragment into pBR 322

The nrd A gene was first cloned by Mileham, Revel, and Murray in 1980, on a 5.2-kb Hind III fragment using a lambda vector system. The 5.2-kb fragment has very recently been shown by sequencing a part of the nrd A ORF, to contain the entire nrd A gene (Chu, F. K., Maley, G. F., Wang, A.-M., Maley, F. 1987). The cloning of nrd A for this thesis first used pBR 322 as a vector. Cloning into pBR 322 was accomplished by cleaving whole cytosine-containing T4 DNA prepared from the multiple mutant phage GT-7 with the Sma I restriction enzyme. A 15.5-kb fragment was purified from the Sma I digest. The purification was achieved by electrophoresing the digest on an agarose gel, slicing out the 15.5-kb band, and electroeluting the fragment from agarose slice. The 15.5-kb fragment was digested next with the Hind III restriction enzyme. The 5.2-kb fragment was purified using the same techniques as before. Once the 5.2-kb fragment was achieved (see Figure 7), the fragment was ligated into the pBR 322 vector opened at the Hind III site and transformed into E. coli RRI cells. Two transformant colonies were obtained which contained the fragment of interest. These two transformants were labeled pnrd 4 and pnrd 6, and were the source of DNA for all molecular biology work done with RDPR in this thesis.

pnrd 4 and pnrd 6 were assayed for RDPR enzyme activity and

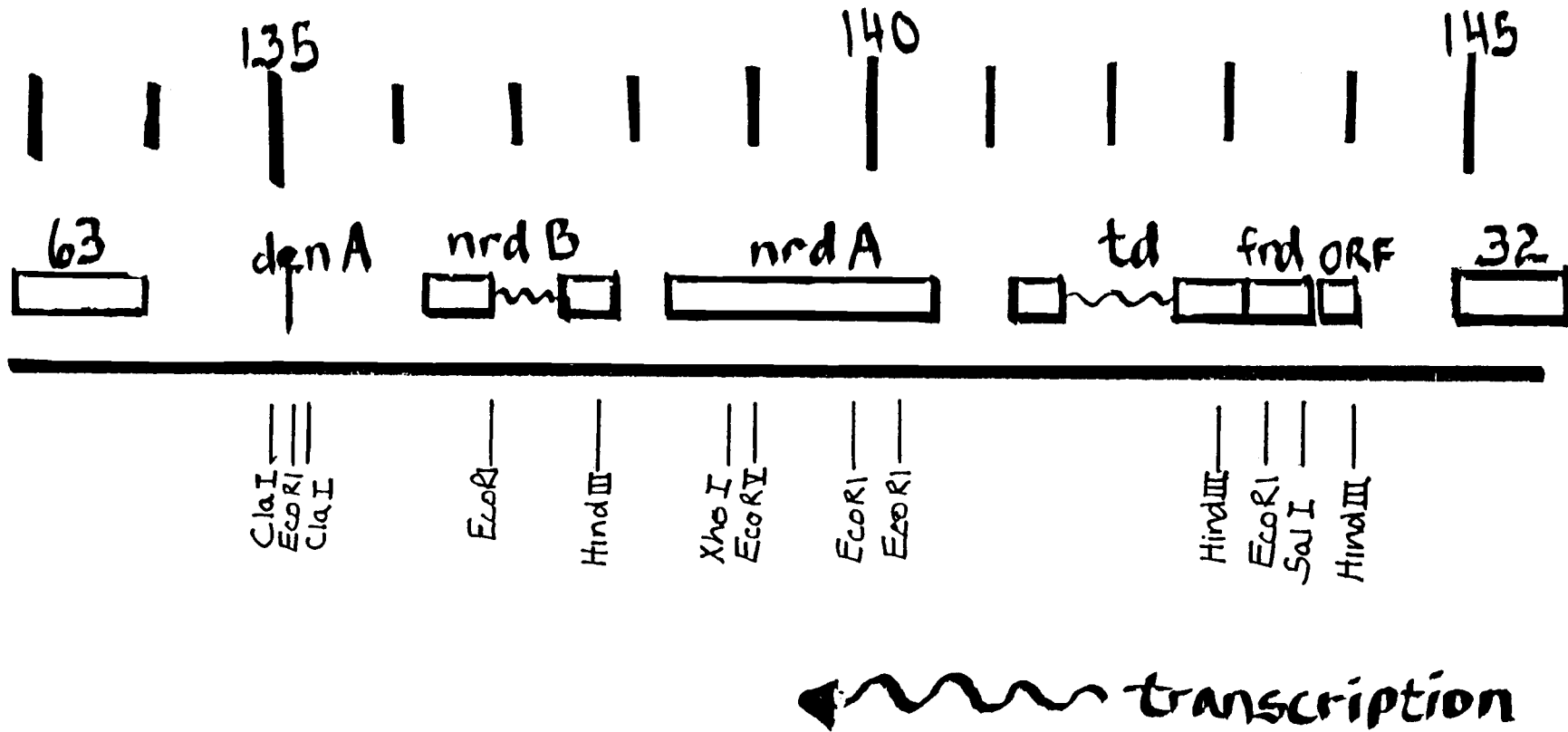

Figure 7. Schematic of the Bacteriophage T4 map between map units 133 and 145. Map units correspond to kilobases, of which there are 166 total in T4.

were found to have no activity (Table 1). It was decided to entertain the possibility that the nrd A promoter may not be strong enough to drive transcription of nrd A and nrd B genes when cloned into E. coli. From the work of Mileham, et. al. (1980), it was evident that at least the nrd A subunit was present on the 5.2-kb Hind III fragment which I had succeeded in cloning into pBR 322. From the genetic maps we were using, it seemed that the nrd B subunit was also coded on the fragment we were cloning.

B. Cloning the 5.2-kb Hind III Fragment into Expression Vector pKC 30

Therefore, for production of RDPR protein, it appeared necessary to use a vector with a strong promoter, such as the P_L promoter of lambda. The P_L promoter is present on the pKC 30 plasmid. Plasmid pKC 30 is a derivative of plasmid pBR 322, containing a Hind III-Bam HI fragment of lambda which contains the P_L promoter, the N gene, and the rho-dependent transcription termination signal t_L (Shimatake, H. and Rosenberg, M., 1981) (see Figure 8). Cloning into the plasmid is done at a site slightly downstream from P_L , an Hpa I site, which occurs in the middle of the N gene. Part of the N gene product is, therefore, expressed in addition, though not as part of the same peptide chain with each overexpressed peptide. The expression system is placed under the control of the experimenter by transforming the pKC 30 plasmid into an E. coli

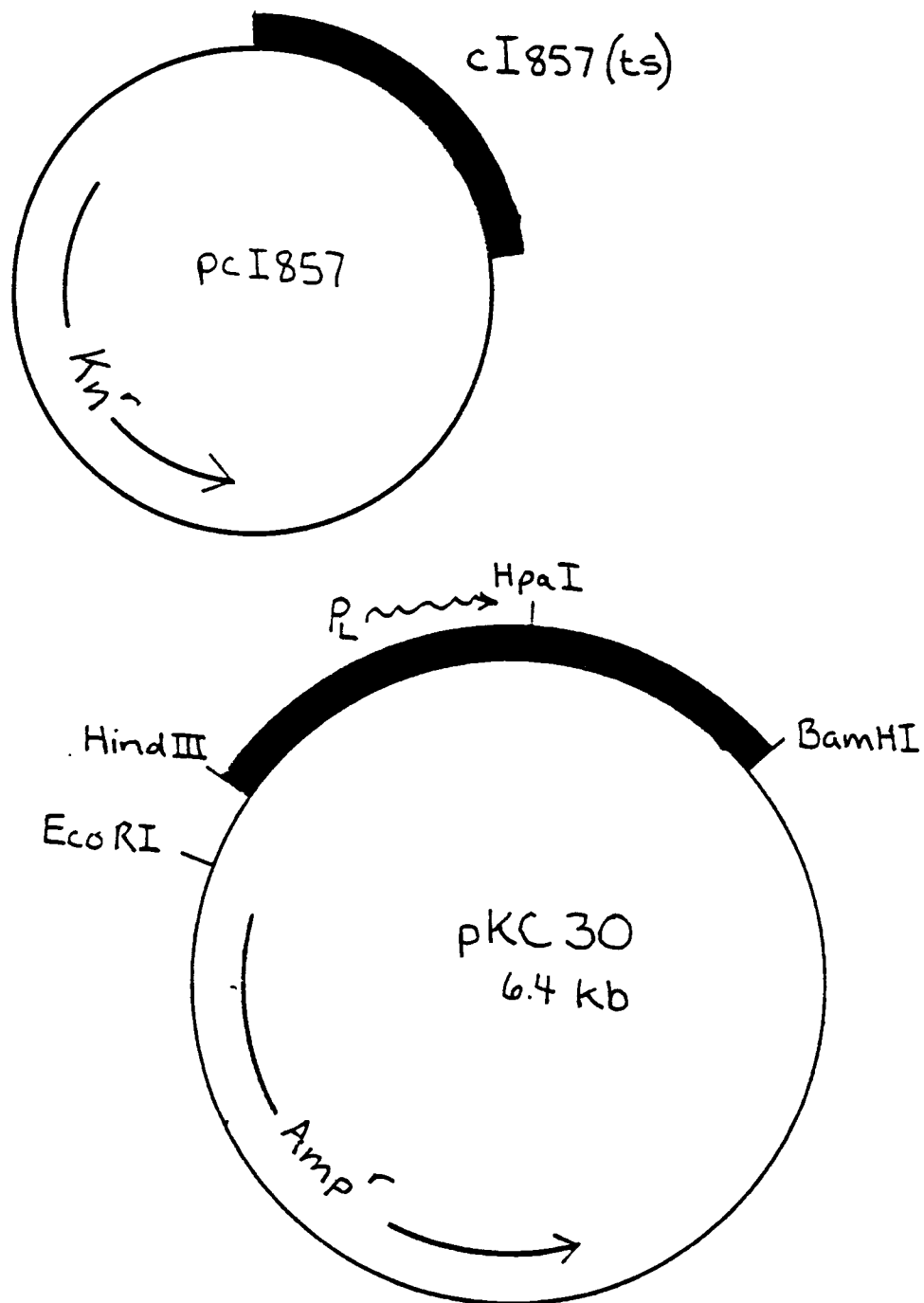

Figure 8. The pKC 30 over-expression plasmid system derived from pBR 322 and lambda. Upon cloning into the Hpa I site of pKC 30, recombinant plasmids are induced to express by raising the temperature to 42°C, thereby inactivating the temperature-sensitive lambda repressor and turning on the P_L promoter.

temperature-sensitive lambda lysogen (clts857). The P_L promoter is tightly controlled by the *cl* gene product, the lambda repressor, and only is released to promote transcription when the lambda repressor is removed from its binding site. In *E. coli* temperature-sensitive lambda lysogens (clts857), the inserts cloned into pKC 30 plasmids are transcriptionally repressed at 35°C or below, and are highly expressed at 42°C or above. In some experiments in this thesis which made use of plasmid pKC 30, the use of lambda lysogenic *E. coli* was avoided by transforming into cells which contained a plasmid which possessed the *cl857* gene. This plasmid, labeled *pcl857*, possessed kanamycin resistance (Figure 8).

An attempt was made to clone the 5.2-kb fragment into the pKC 30 vector. After ligation and transformation, four transformants were achieved. According to restriction analysis, two had more than one 5.2-kb insert--none of the inserts in the proper orientation for expression from the P_L promoter; in one, a single insert was cloned in the opposite orientation; and one was in the correct orientation (Figure 9). The transformant with the 5.2-kb fragment in the proper orientation was labeled pKC 13; the transformant with the fragment in the opposite orientation, pKC 15. Extracts of pKC 13-containing cultures and pKC 15-containing cultures as well as the host control were grown to mid-log at 32 degrees, induced to express by shifting to 42°C, grown for one hour and harvested. After sonicating the cell pellets, aliquots were used in SDS protein electrophoresis. As can be seen from the results in Figure 10, the lane representing pKC

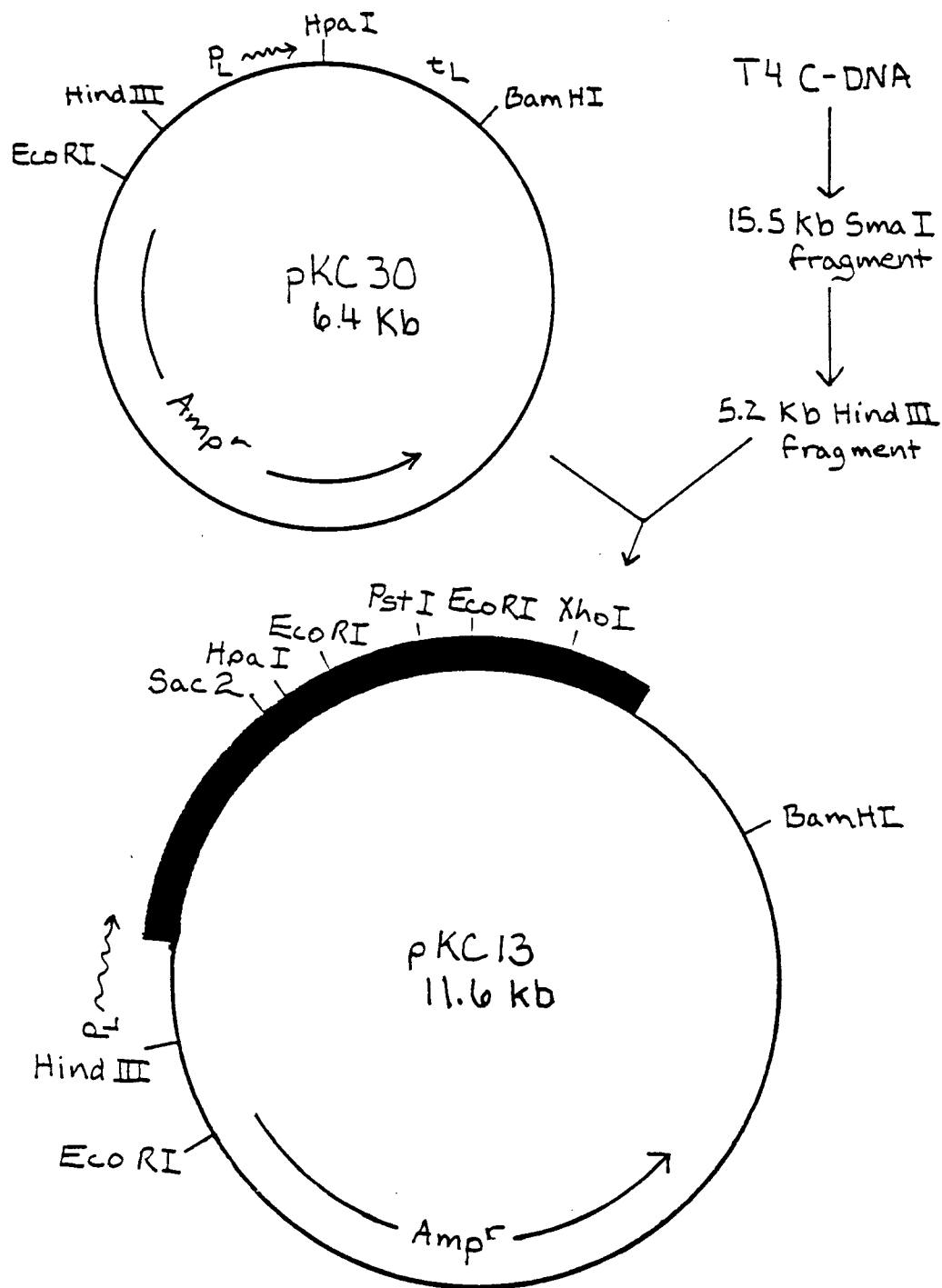

Figure 9. The recombinant plasmid pKC 13 contains elements of pBR 322, lambda, and Bacteriophage T4. When cells were grown which contained plasmids pcli857 and pKC 13, genes contained on the cloned 5.2 kb Hind III fragment on pKC 13 were induced to express by increasing the temperature to 42°C.

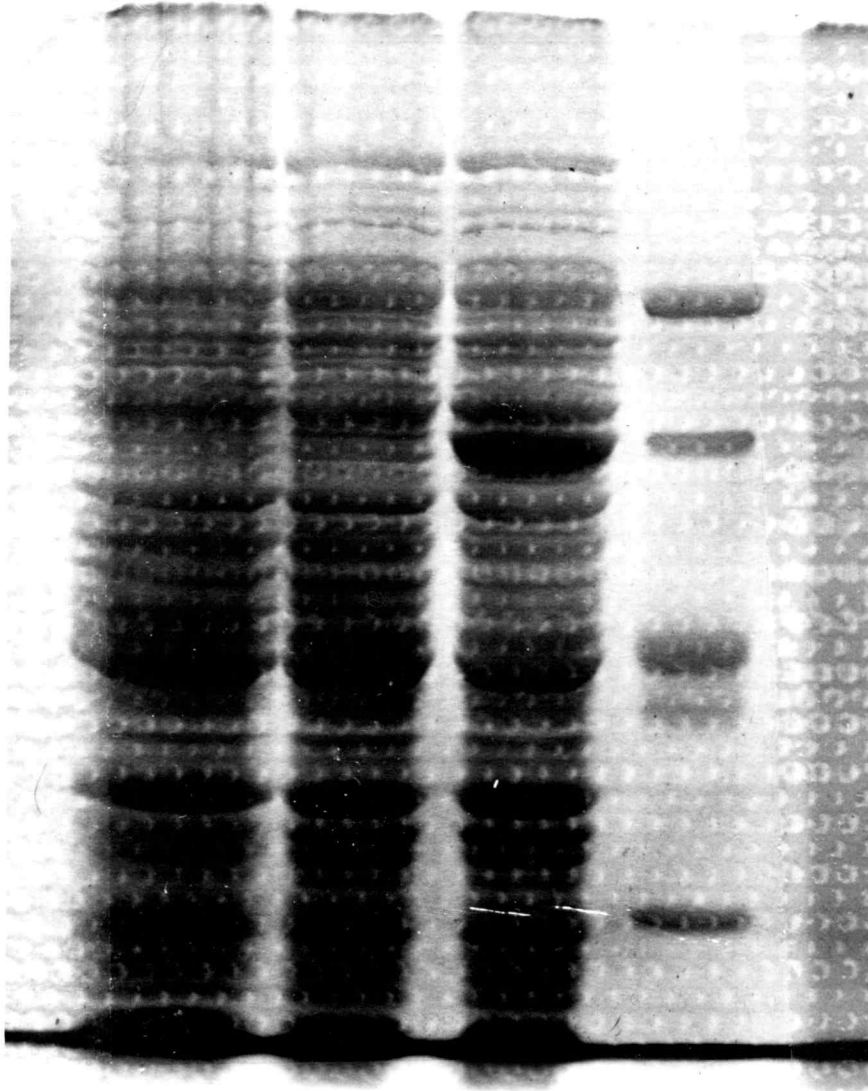

Figure 10. SDS PAGE gel of RRI *E. coli* extracts and size standards. Lane 1 is a crude extract of an RRI culture with only the plasmid pcl857 present in the cell. In lane 2, the cells possessed both pcl857 and pKC 15. pKC 15 is a recombinant plasmid in which the 5.2 kb fragment cloned into pKC 30 was cloned in the opposite direction for transcription. The cells in lane 3 also possessed both pcl857 and pKC 13. In pKC 13, the 5.2 kb fragment was cloned in the proper orientation for expression of the genes present on the fragment.

13-containing cell extracts has a dark band about 60 kDa in size which the other lanes do not have. This represented overexpression of a translated product from the 5.2-kb DNA fragment behind the P_L promoter. No expression of a 60-kDa peptide was seen in control lanes 1 and 2 which represented extracts of the plasmid host and transformant pKC 15. Following SDS gel electrophoresis of the pKC 13 extract, the extract was assayed for ribonucleotide reductase activity. As seen in Table 1, pKC 13 was found not to possess holoenzyme RDPR activity, neither did it possess nrd A subunit activity nor nrd B subunit activity. The individual subunits of RDPR were assayed for by complementation assays using mutants of T4 in the nrd A and the nrd B genes. T4 A67 represented the mutant in the nrd A gene; T4 B55 represented the mutant in the nrd B gene. These assays use infections by T4 phage which possess mutations in the subunit one wishes to assay for, but which possesses a wild-type gene for the other subunit. Infected cell extracts were assayed for RDPR activity in the same way as extracts of cells which were plasmid-containing. As a control, non-plasmid-containing cells were infected by two T4 mutant phage, one phage having a mutation in nrd A and the other phage having a mutation in nrd B. As is seen in the Table, this two-mutant control yields high RDPR activity. Also in the Table are controls for the nrd A and nrd B single-mutant phages. These controls involve infections of the mutant phage into E. coli CR 63 cells. CR 63 is a suppressor-positive strain having an amber-suppressing tRNA. When the T4 nrd A and nrd B mutants were

Ribonucleotide Reductase Assays

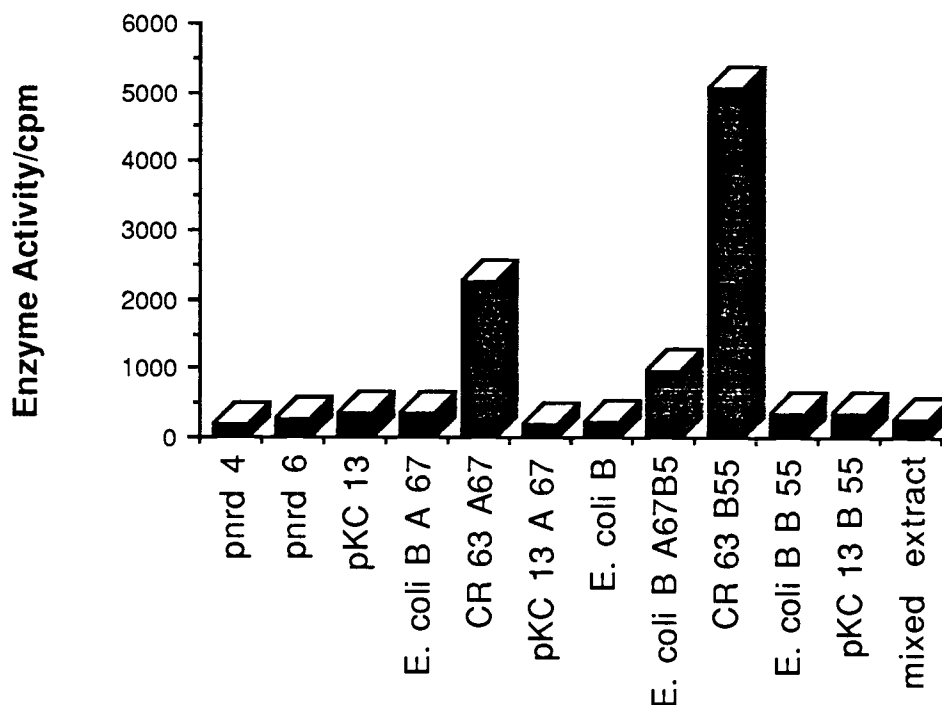

Table 1. A representation of enzymatic activities derived from a variety of cell extracts and infected cell extracts. *E. coli* B represents *E. coli* cells with a suppressor minus phenotype. CR 63 represents *E. coli* which have a suppressor positive phenotype. A67 is a T4 *nrd*⁻ A⁻ phage. B55 is a T4 *nrd*⁻ B⁻ phage. All plasmids were transformed into *E. coli* RRI cells. "Mixed extract" represents a mixture of extracts of *nrd*⁻ A⁻ T4 infections and *nrd*⁻ B⁻ T4 infections. pKC 13 A67 represents the extract of an infection of T4 A67 into *E. coli* RRI cells transformed with pKC 13.

infected into CR 63, the mutations were suppressed and high RDPR activity was the result.

C. Cloning Fragments Downstream of the 5.2 kb Hind III Fragment

The next step in attempting to clone a holoenzyme RDPR was to clone fragments downstream of the 5.2 kb fragment. The 15.5 kb Sma I fragment was again purified and a shotgun cloning experiment was tried. The 15.5 kb fragment was digested with Eco RI, and the Eco RI fragments and an inducible over-expression vector, the pUC vector were ligated together. Several downstream fragments were cloned. A 3.1-kb piece of DNA representing about 1 kb of DNA beyond the 3' end of the 5.2-kb Hind III fragment of DNA (see Figure 7) was cloned. This cloned fragment extends from 136.8 T4 map units to 139.9 map units. Also cloned was a 1.7-kb fragment of DNA distal to the 3.1-kb fragment of DNA. This fragment extends from 135.1 map units to 136.8 map units. It is now known that these fragments together represent segments of DNA which contain nrd A and nrd B in their entirety. The 1.7-kb fragment has been shown to contain the C-terminal 60% of the nrd B gene, as well as a portion of the nrd B intron (Sjoberg, B.-M., Hahne, S., Mathews, C. Z., Mathews, C. K., Rand, K. N., Gait, M. J., 1986). At the time of the cloning of the 5.2-kb, 3.1-kb, and 1.7-kb fragments, however, the position of the nrd A and nrd B genes was not known. It was certainly thought, however, that if the three fragments could be joined in some way, nrd A and nrd B

might be cloned in toto. Unfortunately, there appeared to be no reasonable way to ligate the three fragments, either within a plasmid or without a plasmid. What had been established by cloning the two distal fragments then, was the knowledge that nrd A and nrd B were clonable on smaller fragments. It was hoped that nrd A and nrd B would also be clonable on a single larger fragment as well.

D. DNA Sequencing in the 0.7 kb Eco RI Fragment

Before attempting additional cloning, however, it was decided to firmly position nrd A on the T4 restriction enzyme map. This was done by sequencing a portion of nrd A DNA using dideoxy M13 sequencing. Once a portion of nrd A was sequenced, the sequence of the E. coli B1 subunit could be aligned with the sequence of the nrd A fragment and the starting position of nrd A on the restriction map could be determined. The interior 0.7-kb Eco RI fragment of the 5.2-kb fragment, from map units 139.9 to 140.6 (Figure 11), was purified and used to clone into M13 mp18 to make sequencing clones. From this cloning, thirteen M13(0.7) clones were isolated, 7 in one orientation and four in the opposite orientation. Clones in both orientations were subsequently used in sequencing reactions. The sequencing reaction mixes were loaded onto 40-cm sequencing gels and were electrophoresed. Following electrophoresis, gel drying, and autoradiography, it was found that gels from clones oriented in just one of the orientations gave readable results. Gels of the clones which began near the N-terminus of the nrd A gene--map position

Positioning of the *nrd A* Gene on the 5.2 kb Hind III Fragment

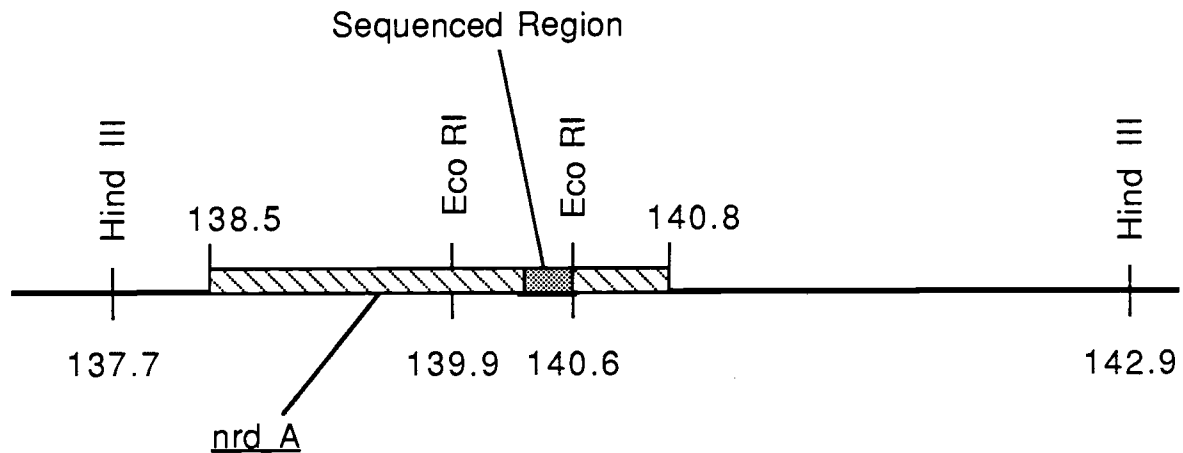

Figure 11. A schematic drawing of the position of the *nrd A* gene on the 5.2 kb Hind III fragment as determined by DNA sequencing of the region between 140.3 and 140.6 map units on the T4 map.

140.6--gave gels with bands readable to 240 bases (Figure 12). Gels of those clones which began at map position 139.9--more near the C-terminus of the *nrd A* gene--repeatedly gave unreadable gels. Their unreadability was due to having multiple bands at each base position. The readable gels were read and analyzed on an Apple Macintosh computer using DNA Inspector II software. Using this software it was found that one of the forward open reading frames ran the entire length through the sequence. No other reading frame in the forward or reverse direction ran throughout the length of the sequence. This open reading frame was translated using DNA Inspector II to produce a sequence of amino acids (see Figure 13). The amino acid sequence was found to possess a high degree of homology to a sequence of the E.

Sequence of Part of 0.7 kb Eco RI Fragment Beginning At 140.6

```

+1  ATTCGGTGG AGCTGATTAT CAATATGTAG CTGCACGFTG TTTAATGTTT GCTCTTCGTA AGCATGTTTA
+71  TGGGCAGTAT GAACCACCAC GTTCATTTAT TGACCATATT TCTTATTGTG TAAATACGAC CCTGAATTAT
+141 TGTCAAAATA TTCAGCAGAA GAAATTACAT TTTTAGAATC AAAAAATTAAG CACGAACGGG ATATGGAAAT
+211 TACTTATTCG GGGCAATGCA ATTTTAAAAG AAAAAATATCT AG

```

Figure 12. Sequence of a region of the 0.7 kb Eco RI fragment located between 140.3 and 140.6 on the T4 map.

coli B1 subunit. In E. coli, the sequence similar to the T4 nrd A sequence is located about 20% of the way into the E. coli B1 sequence, beginning at amino acid 75. As can be seen in Figure 13, the 83 amino acids of the T4 ORF are 62% homologous to this region of the E. coli B1 subunit. This homology locates where the 83 amino acids would lie on an E. coli peptide map. We made the assumption that E. coli B1 and T4 nrd A were enough alike in size to enable us to position fairly accurately where the termini of nrd A would be positioned on the T4 restriction map. The additional assumption was that the 83-amino acid peptide starts at or very near the Eco R1 site at 140.6 map units. This was a reasonable assumption since that was the start site of DNA sequencing in those clones.

Referring to Figure 11, one can see where--based on our sequencing results--nrd A begins on the T4 restriction map. As seen

in the figure, all of nrd A appears to be contained within the 5.2-kb Hind III fragment. This 5.2-kb fragment is that which was cloned already into vectors pBR 322 and pKC 30. An anomaly was thus

T4/E. coli AMINO ACID HOMOLOGY

T4	ADYQY	VAARC	LMFAL	RKHVY	GQYEP	PRSFY	DHISY	CYNAG
<u>E. coli</u>	PDYQY	LAARL	AIFHL	RKKAT	ASLRP	PALY-	DHVYK	MYEMG

T4	KYDPE	LLSKY	SAEEI	TFLES	KIKHE	RDMEF	TYSGQ	CNFKR	KIS
<u>E. coli</u>	KYDNH	LLEDY	TEEEF	KQMDT	FIDHD	RDMTF	SYAAV	KQLEG	KYL

Sequence begins at E. coli residue number 75. 62% homology between peptides.

Figure 13. A transcription of the open reading frame which stretches throughout the T4 sequenced region compared for homology with the amino acid sequence of the large subunit of E. coli RDPR beginning at residue 75. Homology is denoted by bars above homologous peptides. Substitutions between chemically similar residues: ILMVA, RKH, YFW, DE, TS, GA, QN, P, AND C (Caras et. al., 1985).

apparent: (1) Based on sequencing results, nrd A appeared to be fully cloned within pKC 30; (2) in over-expression conditions when an 84-kDa protein should be transcribed, only a fragment of the entire protein was expressed. The problem did not seem to be with the size or state of the fragment cloned into the plasmid vectors, since all of the expected restriction fragments were present upon digestion of the achieved clones. The problem could have been an anomaly in the DNA

sequence of the cloned fragment, perhaps a speciously introduced stop codon.

E. coli ³⁵S Autoradiography of pKC 13 Extracts

One of the scenarios that was considered was that an 84-kDa protein was expressed in pKC 13-containing cells but that cellular proteases caused the cleavage of the 84-kDa protein down to one of 60-kDa. It is known that the nrd B subunit protects the nrd A subunit

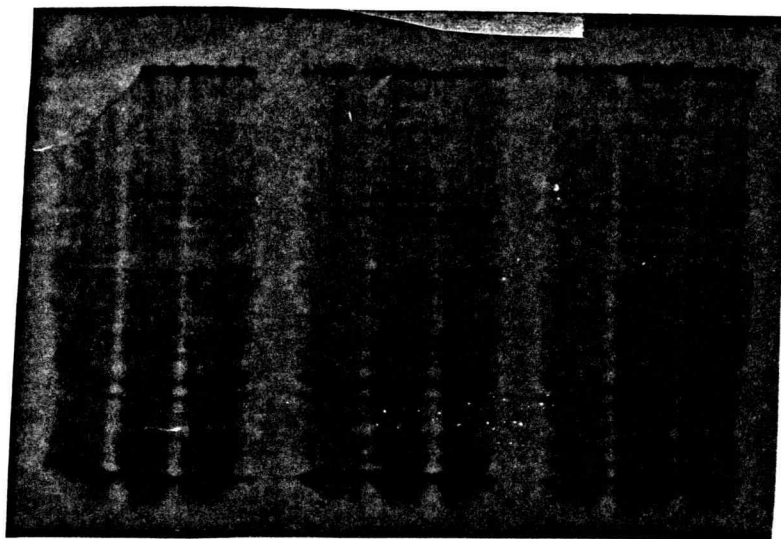

Figure 14. Autoradiography of ³⁵S-labeled peptides from cell extracts of E. coli RRI transformed by (1) pcl857; (2) pcl857 and pKC 13; (3) pcl857 and pKC 15.

from protease attack in holoenzymes (Cook, K. S., Greenberg, G. R., 1983). On infection by nrd B mutant T4 not forming nrd B protein, the

nrd A protein was found to be specifically to form three protein chains. We decided to use S^{35} cell autoradiography (Sancar, A., Hack, A. M. and Rupp, W. D., 1979) in an attempt to visualize all of the peptides coded for by plasmid pKC 13 on SDS PAGE gels. The autoradiography experiments were tried; the label was added when the P_L promoter was temperature induced. It was hoped that with autoradiography, even a small amount of the 84-kDa peptide might be visualized in the pKC 13-containing cell extracts. As can be seen from Figure 14, the background cellular proteins were in every case too high in concentration to enable one to see weak bands in the 84-kDa region. Many parameters were changed in an effort to decrease the background, but none were successful.

F. The Attempt to Clone the 8.2 kb Sal I-Cla I Fragment

The next technique tried was an effort to achieve cloned nrd A and nrd B subunits on the same clone. A fragment which was long enough to fully include both subunits was purified. The purified fragment was called the 8.2-kb Sal I-Cla I fragment. It extends from map unit 135.3 to map unit 143.5. It was purified from the same 15.5-kb fragment as the 5.2-kb fragment. As can be seen from Figure 7, the fragment contains gene fragments from frd to den A and all of the region where nrd A and nrd B are shown to be. It was decided to clone the 8.2-kb Sal I-Cla I fragment into pBR 322, one of the easiest vectors to clone into. Multiple ligations and transformations were attempted but none with any success. No clones were achieved with

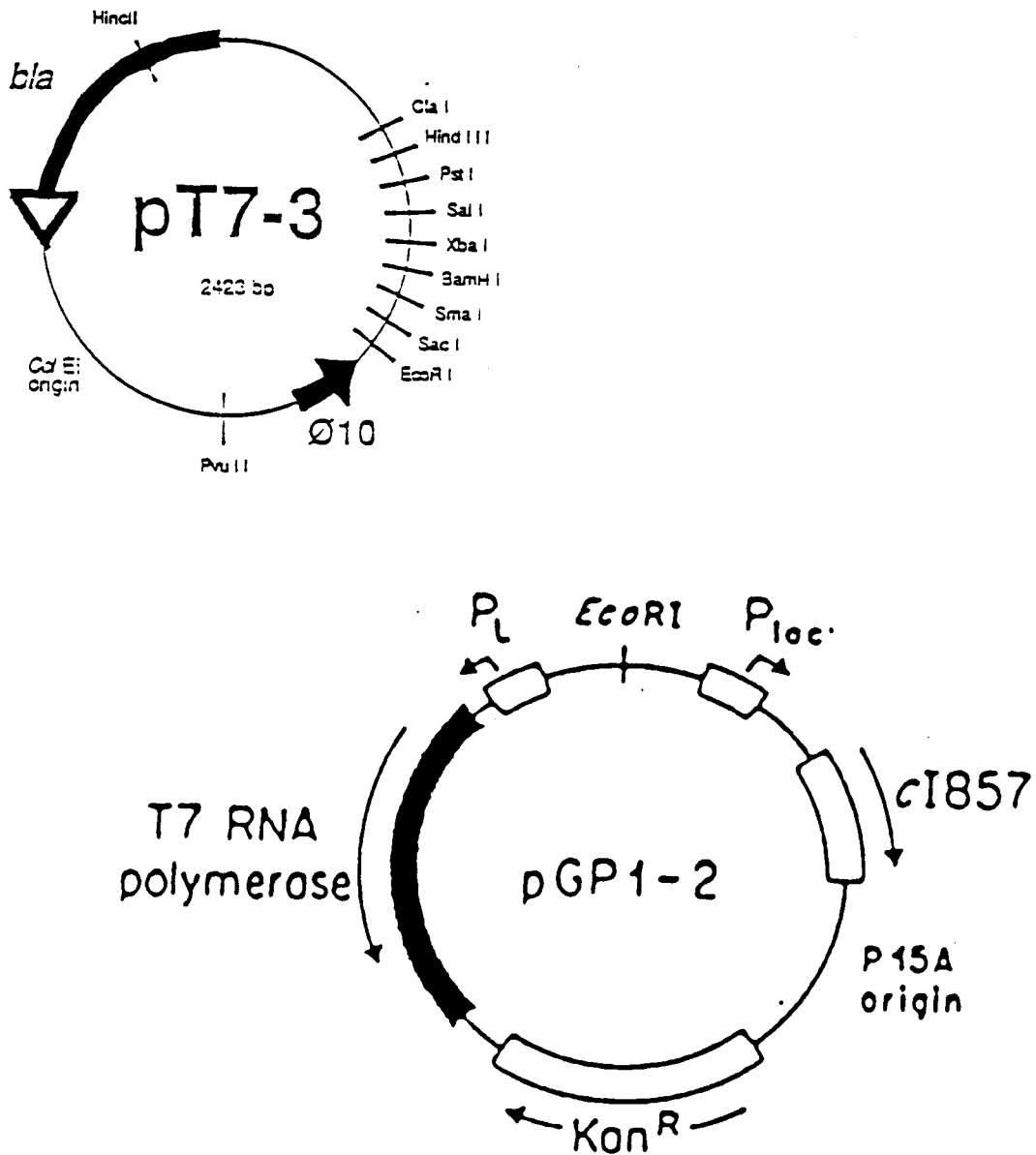

Figure 15. The two plasmids of the pT7 system for over-expression of proteins from cloned genes. Upon heat induction, transcription is initiated at the P_L promoter on pGP1-2. The gene for T7 RNA polymerase is transcribed, and large quantities of the RNA polymerase are produced. The RNA polymerase recognizes the strong T7 ϕ -10 promoter on pT7-3, and genes cloned into the pT7-3 polylinker are highly expressed.

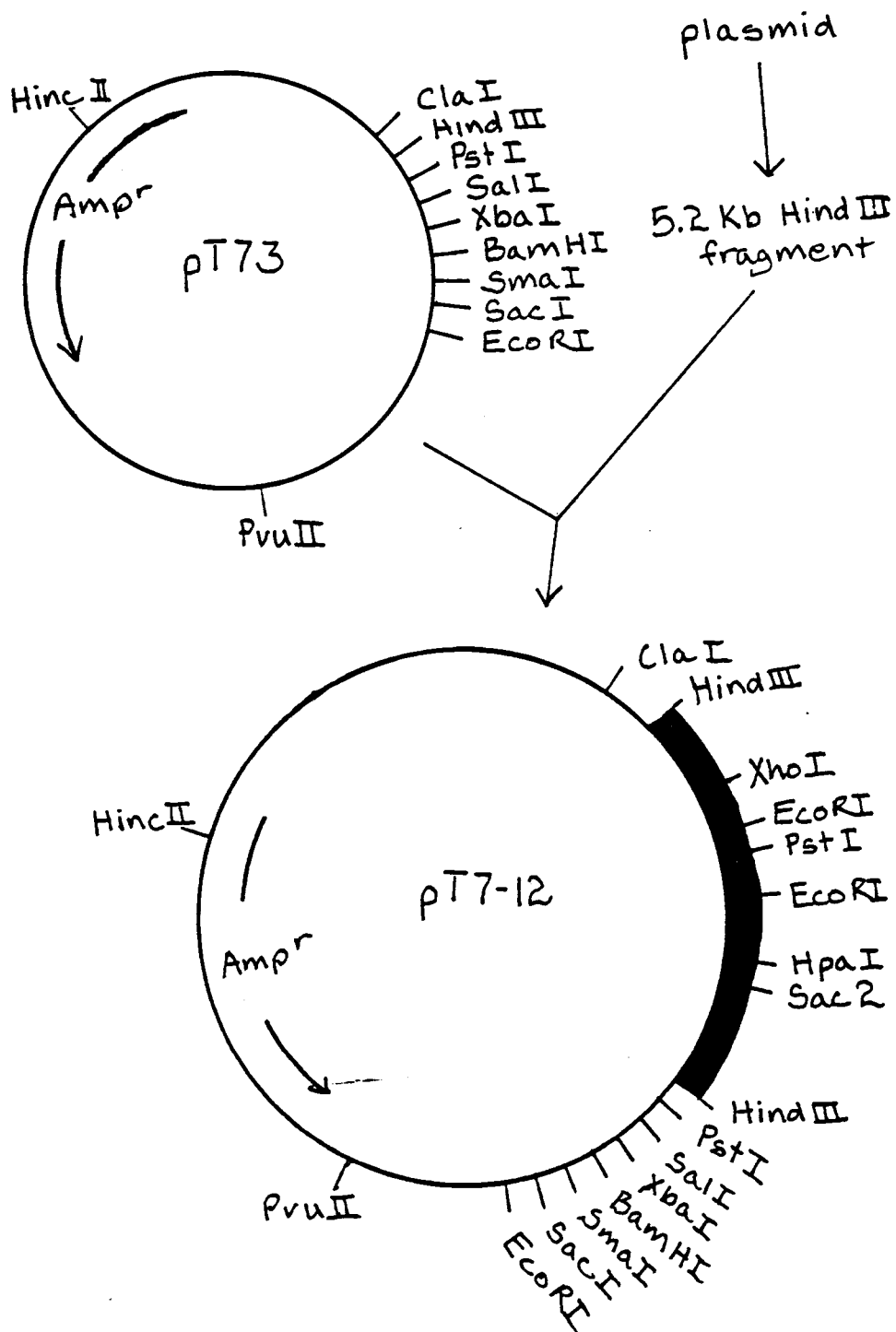

Figure 16. The construction of the recombinant plasmid pT7-12. The orientation of the 5.2 kb *Hind III* fragment in pT7-12 was determined by restriction enzyme digests.

the 8.2-kb/pBR 322 cloning. This is another instance of the unclonability of a larger fragment while all the small fragments of the large fragment are clonable.

G. Cloning the 5.2 kb Hind III Fragment into the pT73 Vector

Following this, it was decided to try cloning the 5.2-kb Hind III fragment into a different expression vector. Perhaps the nrd A subunit was being truncated to form 60-kDa peptides by some system associated with the pKC 30 vector. The expression system chosen to re-clone the 5.2-kb Hind III fragment was the T7 expression system using the T7 promoter from gene 1 of T7 (Tabor, S. and Richardson, C. C., 1985). The unique aspect of this system is that a plasmid-coded T7 RNA polymerase is used as the polymerase for the inserted gene (Figure 15). Using the T7 RNA polymerase and the T7 promoter, very high expression of the inserted gene can be achieved. The expression system is under the control of the experimenter, also, since induction of the over-expressing polymerase only occurs at 42°C. This would seem to be one of the perfect over-expressing systems then, with many advantages and few disadvantages. 5.2-kb fragments purified from the original pnrd 6 clones were those used to clone into pT73, the T7 vector. After scanning many transformants using minipreps, one was found which had the 5.2-kb fragment in the proper orientation (Figure 16). Unfortunately, the transformant with the 5.2-kb fragment properly inserted did not yield over-expression of either the 84-kDa nrd A protein or the 60-kDa peptide. It is not known why an

over-expression protein was not achieved using this system. It is known to us that three research groups around the world are at this time attempting the cloning of the nrd A gene--and as of this writing have had no success (personal communication, B.-M. Sjoberg). It may just be an anomaly of working with the nrd A gene. The stubbornness of the nrd A gene to be cloned may be a topic for future researchers to consider.

H. Attempted Purification of the 60-kDa Peptide

The final section of Results/Discussion concerns the attempt to purify the 60-kDa peptide. The interest in purifying the 60-kDa peptide lay in achieving purified samples of the peptide that can be used to achieve an amino acid sequence of the peptide as well as antibodies to the peptide. It is possible that the antibodies can be used to determine quantities of the 84-kDa holoenzyme when it is purified.

The first difficulty encountered in purifying the 60-kDa peptide was that the peptide was not soluble in aqueous solvents. Upon cell lysis, the 60-kDa peptide was completely insoluble. If solubilizing agents were not included in the lysis buffer, the lysed cells of a culture of over-expressed cells exhibited a chalky, white precipitate. The white precipitate remained even after the use of heat, or after sonication or the French press. The solubilizing agents that have been tried include the following: Tween 20, cholate, deoxycholate, Triton X-100, NP-40, Brij 58, SDS, guanidium hydrochloride, beta

mercaptoethanol, urea, formic acid, ketones, and pH changes from 2 to 10.5. The only solubilizing agents that were found to bring the 60-kDa peptide into solution were 0.5 % or greater SDS, and 6 M or greater urea. These agents appeared to solubilize the peptide to completion. Following solubilization of the 60-kDa peptide, the aim was to purify it away from the proteins of the cell sonicate using column chromatography.

Initially, ion-exchange chromatography was used in an effort to purify the 60-kDa peptide. First DEAE; then QAE; then CM-Sephadex were tried. None of the ion-exchange columns succeeded in binding the 60-kDa peptide to the column matrix. SDS PAGE gels which were used to assay the fractions from the columns always exhibited the 60-kDa peptide band at the break-through of the columns. Tris-buffered SDS and Tris-buffered 6 M urea solvents were both used to elute the columns. Using solvents with denaturants probably caused the 60-kDa peptide to not stick to the functional groups on the columns.

Phenylsepharose was a column matrix also used in the attempted purification of the 60-kDa peptide. The 60-kDa peptide appeared to be a hydrophobic protein owing to its insolubility in aqueous solution. The phenylsepharose matrix, which separates based on the hydrophobicity of a protein, therefore seemed to be a good matrix choice. After trying many gradients of different phosphate concentration and SDS or urea solvent type, no separation was achieved. Again, the gels used to assay fractions from phenylsepharose column runs always exhibited the 60-kDa peptide in

the first fractions coming off the column.

The next column type tried was hydroxyapatite. After some manipulation, phosphate gradient concentrations were found which separated the 60-kDa peptide fairly well from the bulk of other proteins. It appeared that hydroxyapatite would be a good selection as a chromatography matrix for purification of the 60-kDa peptide. It was not possible, however, to achieve a completely purified protein from chromatography on just the hydroxyapatite column. It was deemed necessary that a second chromatography column of different type be utilized in the purification of the 60-kDa peptide.

Another column which was tried in the attempted purification was a G-75 Sephadex gel filtration column. After several trials with SDS buffers as well as urea buffers, a slight purification was found with the 6 M urea buffer. A tremendous decrease in concentration was also experienced, however, with the gel filtration column, thus decreasing its utility. Sufficient purification of the 60-kDa peptide was not achieved using the column techniques outlined for the purposes for which we had proposed.

REFERENCES

- Albert, D. A. and Gudas, L. J. (1985) . J. Biol. Chem. **260**, 679.
- Allen, J. R., Reddy, G. P. V., Lasser, G. W., Mathews, C. K. (1980) . J. Biol. Chem. **255**, 7583.
- Ator, M. and Stubbe, J. (1985) . Biochemistry. **24**, 7214.
- Ator, M. A., Stubbe, J., Spector, T. (1986) . J. Biol. Chem. **261**, 3595.
- Babior, B. M. (1975) . Acc. Chem. Res. **8**, 376.
- Belfort, M., Moelleken, A., Maley, G. F., Maley, F. (1983) . J. Biol. Chem. **258**, 2045.
- Belfort, M., Pedersen-Lane, J., Ehrenman, K., Chu, F. K., Maley, G. F., Maley, F., McPheeters, D. S., Gold, L. (1986) . Gene. **41**, 93.
- Berglund, O. (1975) . J. Biol. Chem. **250**, 7450.
- Berglund, O. (1972) . J. Biol. Chem. **247**, 7270.
- Broida, J. and Abelson, J. (1985) . J. Mol. Bio. **185**, 545.
- Brown, N. C., Eliasson, R., Reichard, P., Thelander, L. (1969) . Eur. J. Biochem. **9**, 512.
- Carlson, J., Fuchs, J., Messing, J. (1984) . Proc. Natl. Acad. Sci. USA. **81**, 4294.
- Chiu, C.-S., Cook, K. S., Greenberg, G. R. (1982) . J. Biol. Chem. **257**, 15,087.
- Chu, F. K., Maley, G. F., Wang, A.-M., Maley, F. (1987) . Gene. **57**, 143.
- Coderre, J., Beverley, S. M., Schimke, R. T., Santi, D. V. (1980) . Proc. Natl. Acad. Sci. USA. **80**, 2132.
- Cook, K. S., Greenberg, G. R. (1983) . J. Biol. Chem. **258**, 6064.
- Goldfarb, A., Broida, J., Abelson, J. (1982) . J. Mol. Biol. **160**, 579.
- Ehrenberg, A. and Reichard, P. (1972) . J. Biol. Chem. **247**, 3485.
- Engstrom, Y., Eriksson, S., Thelander, L., Akerman, M. (1979) . Biochem. **18**, 2948.

- Eriksson, S., Graslund, A., Skog, S., Thelander, L., and Tribukait, B. (1985) . J. Biol. Chem. **259**, 11,695.
- Eriksson, S. and Martin, D. W., Jr. (1981) . J. Biol. Chem. **256**, 9436.
- Eriksson, S. and Sjoberg, B.-M. (1988) . "Ribonucleotide Reductase", in press.
- Fukada, Gossens, and Abelson (1980) . J. Mol. Biol. **137**, 213.
- Gott, J. M., Shub, D. A., Belfort, M. (1986) . Cell. **47**, 81.
- Hibner, U. and Alberts, B. (1980) . Nature. **285**, 300.
- Hogenkamp, H. P. C. and Sando, G. N. (1974) . The enzymatic reduction of ribonucleotides, in: Structure and Bonding (eds.) Dunitz, J. D. et. al., Vol. **20**, p. 24, New York, Springer-Verlag 1974.
- Holmgren, A. (1981) . TIBS. 1981. 26.
- Holmgren, A. (1985) . Ann. Rev. Biochem. **54**, 237.
- Holmgren, A. (1979) . J. Biol. Chem. **254**, 3664.
- Huszar, D., Bacchetti, S. (1983) . Nature. **302**, 76.
- Joelson, T., Uhlin, U., Eklund, H., Sjoberg, B.-M., Hahne, S., Karlsson, M. (1984) . J. Biol. Chem.
- Kroger, M., and Hobom, G. (1982) . Gene. **20**, 25.
- Lamm, N., Wang, Y., Mathews, C. K., Ruger, W. (1988) . Eur. J. Biochem. **172**, 553.
- Lankinen, J., Graslund, A., Thelander, L. (1982) . J. Virol. **41**, 893.
- Larsson, A. and Reichard, P. (1966) . J. Biol. Chem. **241**, 2533.
- Lunn, C. A., Pigiet, V. (1979) . J. Biol. Chem. **254**, 5008.
- Maniatis, T., Fritsch, E. F., Sambrook, J. (1982) . Molecular Cloning. Publ.: Cold Spring Harbor Laboratory.
- Mathews, C. K., and Sinha, N. K. (1982) . Proc. Natl. Acad. Sci. USA. **79**, 302.
- Mileham, A. J., Revel, H. R., Murray, N. E. (1980) . Mol. Gen. Genet. **179**, 227.

- Noguchi, H., Reddy, G. P. V., Pardee, A. B. (1983). *Cell*. **32**, 443.
- Nordenskjold, B. A., Skoog, L., Brown, N. C., Reichard, P. (1970). *J. Biol. Chem.* **245**, 5360.
- North, Thomas (1976) Ph. D. thesis, University of Arizona.
- Platz, A. and Sjoberg, B.-M. (1980). *J. Bact.* **143**, 561.
- Purohit, S., Mathews, C. K. (1984). *J. Biol. Chem.* **259**, 6261.
- Sahlin, M., Ehrenberg, A., Graslund, A., Sjoberg, B.-M. (1986). *J. Biol. Chem.* **261**, 2778.
- Sancar, A., Hack, A. M. and Rupp, W. D. (1979). *J. Bact.* **137**, 692.
- Sando, G. N. and Hogenkamp, H. P. C. (1973). *Biochem.* **12**, 3316.
- Schimpff-Weiland, G., Follmann, H., Auling, G. (1981). *Biochem. Biophys. Res. Comm.* **102**, 1276.
- Shimatake, H. and Rosenberg, M. (1981). *Nature*. **292**, 128.
- Shub, D. A., Gott, J. M., Xu, M.-Q., Lang, B. F., Michel, F., Tomaschewski, J., Pedersen-Lane, J., Belfort, M. (1988). *Proc. Natl. Acad. Sci. USA.* **85**, 1151.
- Sjoberg, B.-M., Graslund, A. and Eckstein, F. (1983). *J. Biol. Chem.* **258**, 8060.
- Sjoberg, B.-M., Hahne, S., Mathews, C. Z., Mathews, C. K., Rand, K. N., Gait, M. J. (1986). *EMBO J.* **5**, 2031.
- Sjoberg, B.-M., Karlsson, M., Jornvall, H. (1987). *J. Biol. Chem.* **262**, 9736.
- Slabaugh, M. B., Mathews, C. K. (1984). *J. Virol.* **52**, 501.
- Soderberg, B. O., Sjoberg, B.-M., Sonnerstam, U., Branden, C.-I. (1978). *Proc. Natl. Acad. Sci. USA.* **75**, 5827.
- Spector, T. and Jones, T. E. (1985). *J. Biol. Chem.* **260**, 8694.
- Tabor, S. and Richardson, C. C. (1985). *Proc. Natl. Acad. Sci. USA.* **82**, 1074.
- Tengelsen, L. A., Slabaugh, M. B., Bibler, J. K., Hruby, D. E. (1988). *Virology.* **164**, 121.
- Thelander, L. and Berg, P. (1986). *Mol. Cell. Biol.* **6**, 3433.

Wickremasinghe, R. G., Yaxley, J. C., Hoffbrand, A. V. (1982) . Eur. J. Biochem. **126**, 589.

Wilson, G. G., Tanyashin, V. I., Murray, N. E. (1977) . Molec. Gen. Genet. **156**, 203

von Döbeln, U. and Reichard, P. (1976) . J. Biol. Chem. **251**, 3616.

Youdale, T., Whitfield, J. F., Rixon, R. H. (1985) . Can. J. Biochem. Cell Biol. **63**, 319.

APPENDICES

APPENDICES

A. Attempted Cloning of T4 Gene 1

In this thesis work there were several genes of nucleotide metabolizing enzymes whose clonings were attempted before the attempted cloning of the nrd A and B genes. Initially, it was of interest to clone the gene which codes for the enzyme monophosphokinase (MPK). This gene is called gene 1. T4 MPK is responsible for phosphorylating the nucleotides dTMP, dGMP, and hydroxymethyl dCMP. MPK of T4 is a novel enzyme among monophosphate kinases. Only the MPKs of bacteriophages T4 and T5 have the capacity to phosphorylate three different nucleoside monophosphates. The reason they possess such a character is still a mystery. It was hoped that by cloning gene 1 and achieving its expression and purification some insight into its peculiar nature could be achieved.

Initially, a 6.5 kb-Sal I Bgl I fragment on which it was known gene 1 existed was used to try to clone the gene (Goldfarb, A., Broida, J., Abelson, J., 1982) (between 73 and 79 map units in Figure A.1). This approach produced no transformants. The reason for the absence of clones using this fragment is that undoubtedly "lethal" DNA is contained in the Sal I-Bgl I fragment. In the paper of Fukada et. al., 1980, the cloning of many small fragments in this region was attempted. They found that a number of areas in this region contained "lethal" or unclonable DNA. No reason was found, but the evidence was

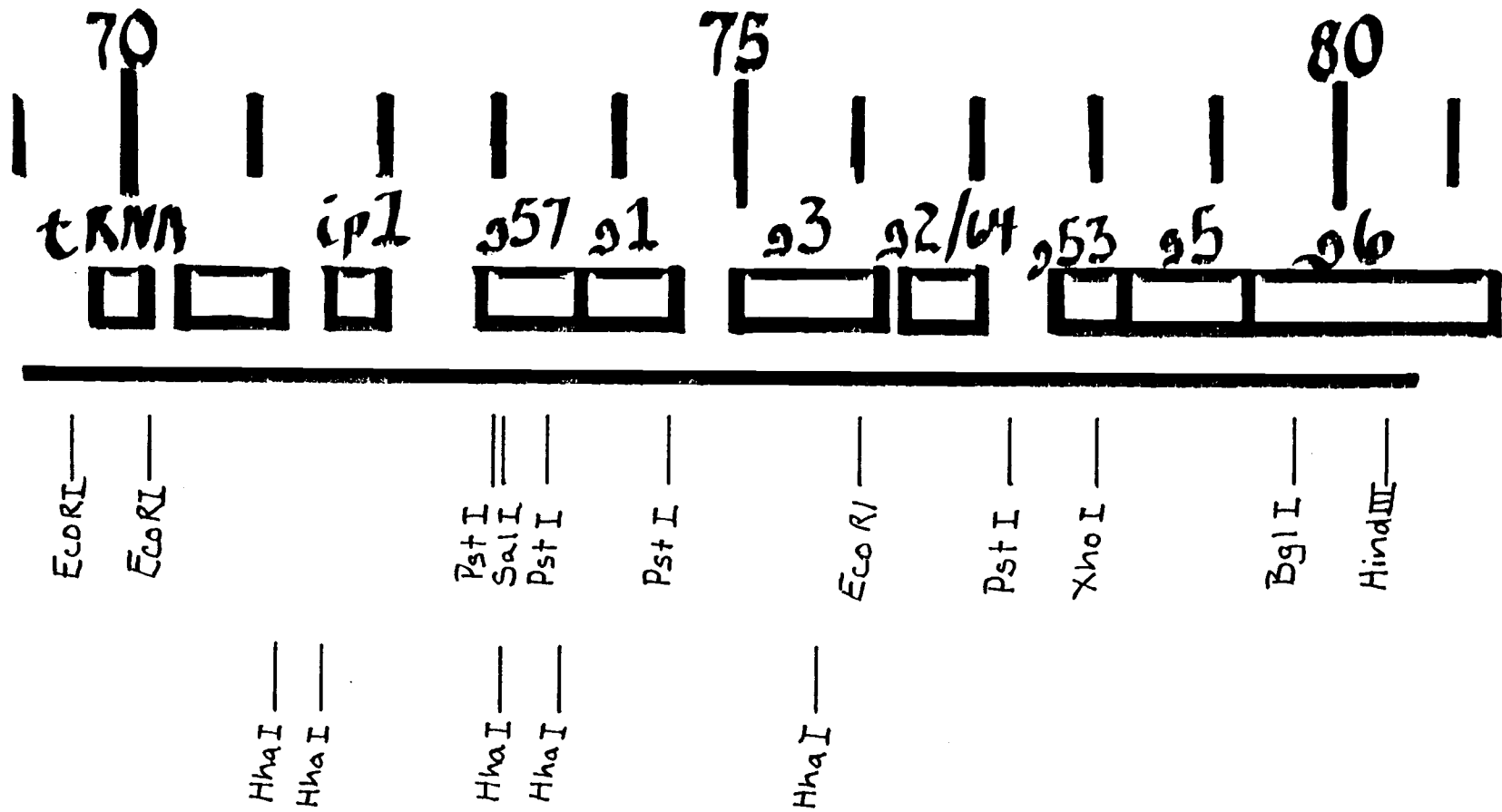

Figure A.1. Schematic of Bacteriophage T4 map between map units 69 and 81.

irrefutable that in many areas in this region the achievement of clones was impossible.

When attempted clonings in the region of gene I span the region of unclonable DNA, the result has been sizable deletions in the DNA. The area of the deletions occurs quite close to the mapped and sequenced gene 1 (Goldfarb, A., Broida, J., Abelson, J., 1982). Sequencing was possible by using quite small fragments for M13 cloning (Broida, J. and Abelson, J., 1985). Restriction enzyme sites were mapped for several enzymes. Upon scanning the various restriction enzyme sites possible for constructing a restriction fragment for gene 1 without including lethal DNA, it was seen that a Hha I fragment of 2.16 kb gave the best result (between 2700 and 4800 units in Figure A.2). This 2.16-kb Hha I restriction fragment was then purified from a 9.5-kb Xho I fragment which itself was purified from whole 170-kb T4 cytosine-DNA. The 2.16 kb fragment was then made blunt-ended and ligated into pUC 19 vectors which had been opened at the Sma I restriction site. After several transformations, four transformants were achieved. After restriction analysis, it was apparent that the clones, although all the same, did not possess the 2.16-kb fragment.

Future attempts to clone gene 1 should start by contacting the lab of John Abelson and checking to see if his lab possesses any DNA fragments which might be useful. Additionally, use of the 2.16-kb fragment in a plasmid vector using the tighter P_L promoter for run-away expression might be more advisable in subsequent cloning attempts.

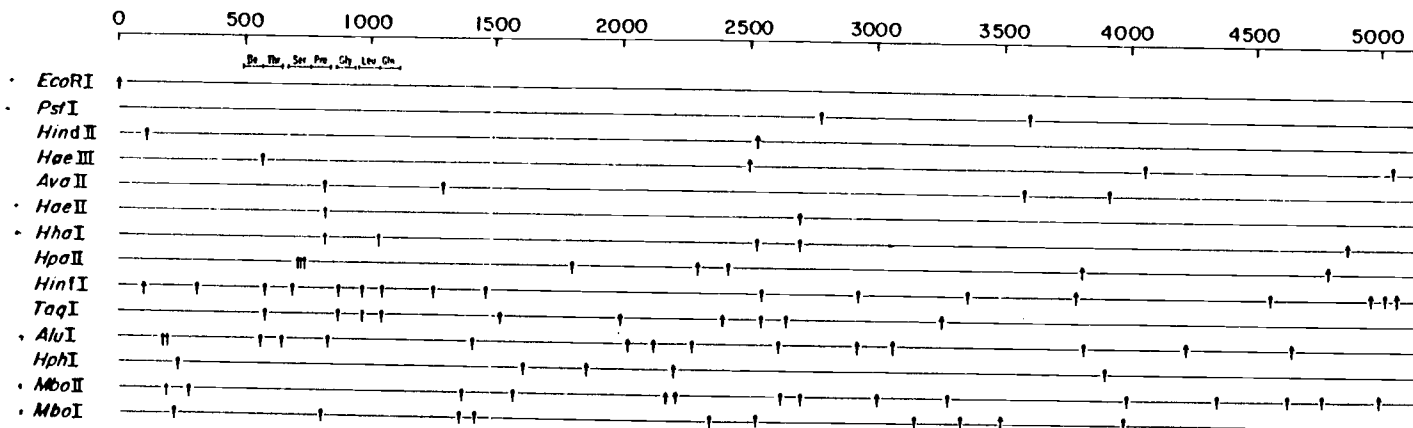

Figure A.2. Restriction map of a 5.2 kb *EcoRI* fragment located between 70.3 and 75.5 map units on the Bacteriophage T4 map. (Fukada et. al., 1980)

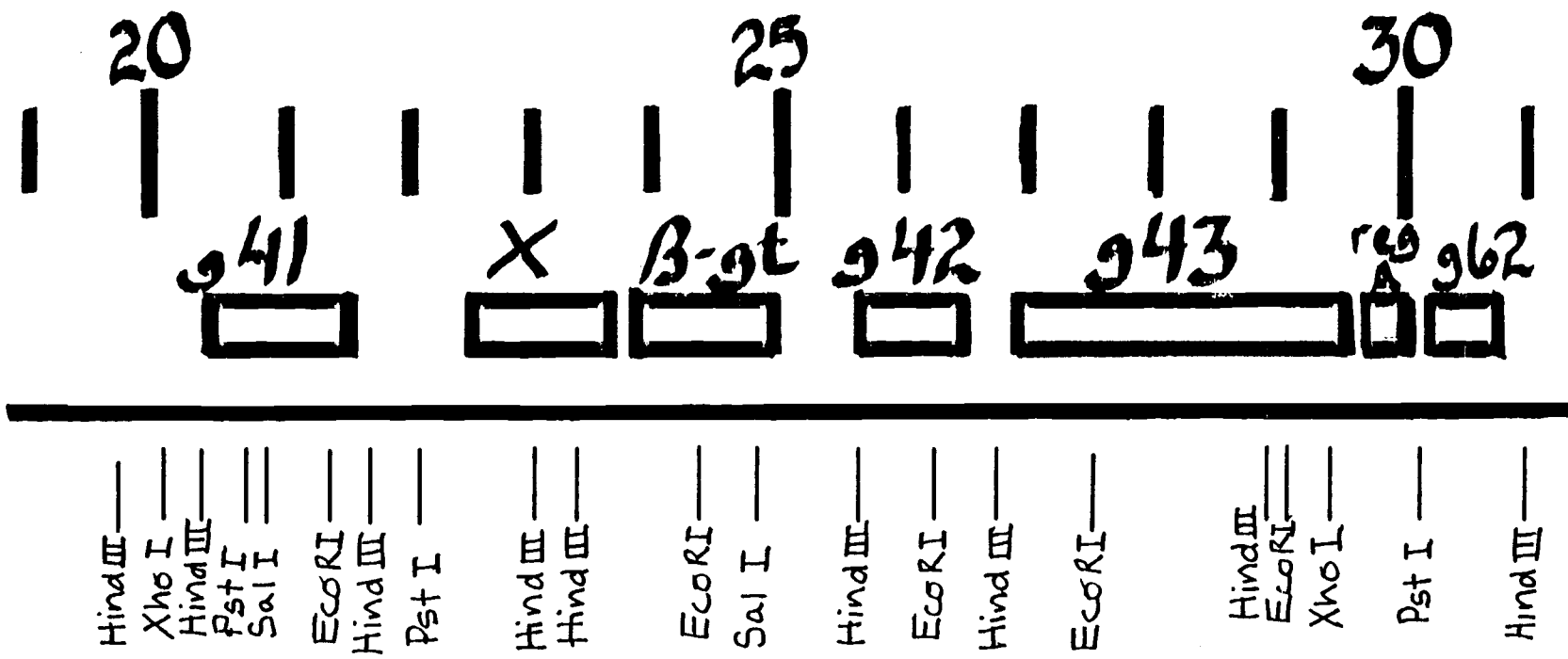

Figure A.3. Schematic of Bacteriophage T4 map between map units 19 and 21.

B. Attempted Cloning of T4 Gene 42

The cloning of gene 42, the gene coding for dCMP hydroxymethylase was also attempted. A 9.0-kb Xho I restriction fragment extending from 20.3 to 29.3 T4 map units (Figure A.3) was purified and ligated to a Xba I-cut pUC 19 vector. Although several attempts were made to clone the fragment, no transformant colonies were ever achieved. Subsequently, hydroxymethylase was cloned by another researcher (Lamm, N., Wang, Y., Mathews, C. K., Ruger, W., 1988).

C. Cloning of T4 *frd* and *td*

Although the individual genes had previously been cloned, the cloning of another two genes was embarked upon. The genes *frd* and *td*, coding for dihydrofolate reductase and thymidylate synthase have been cloned by other researchers (Belfort, M., Moelleken, A., Maley, G. F., Maley, F., 1983; Purohit, S., Mathews, C. K., 1984). A very interesting thing was discovered about the two genes upon their sequencing, however. It was found that *frd* and *td* overlap each other at the C-terminus of *frd* by 4 base pairs, ATGA. This overlap occurs several times in lambda and is thought to play a role in gene regulation at the translational level (Kroger, M., and Hobom, G., 1982). Additionally, in certain protozoan parasites (Coderre, J., Beverley, S. M., Schimke, R. T., Santi, D. V., 1980) there exists a bifunctional dihydrofolate reductase-thymidylate synthase. In *Crithidia*

fasciculata, the enzyme is a dimer with subunits of 56,700 daltons--very close to the sum of the molecular weights of T4 dihydrofolate reductase and thymidylate synthase. A simple fission of the genes of frd and td in an ancestral genome could have resulted in the juxtaposition of the two genes in T4 that we see today.

The project with these two genes was to construct a clone wherein frd and td were present side by side as in the T4 genome. This was then to be sent to our collaborators for site-specific mutagenesis at the site of the overlap of the two genes. It was intended that a single base-pair be removed from the frd C-terminus, thereby converting frd and td into a single gene.

To begin the project, a 0.75-kb DNA fragment representing three-quarters of the N-terminus of the frd gene was cloned into pUC19, a run-away expression vector. The advantages of the pUC vectors are that they possess polylinkers for cloning as well as lac operon promoters for runaway transcription and overexpression of the cloned gene. The 0.75-kb fragment was derived from a 15.5-kb fragment which was purified from whole 170-kb T4 DNA. Next, a 2.85-kb fragment of the 15.5-kb Sma I fragment was cloned into the previously constructed (0.75)-pUC 19. The 2.85-kb fragment contains all of the td gene. The plasmid thus achieved, labeled p(3.35)-UC, theoretically contains both the gene for dihydrofolate reductase as well as the gene for thymidylate synthase. Testing the proper insertion of both fragments involves the restriction digestion of the recombinant plasmid with Hind III and Eco RI restriction enzymes. Once cleaved, and fragments analyzed, it was clear that the final

recombinant possessed the fragments desired. The final test would be to see if both dihydrofolate reductase and thymidylate synthase both would be overexpressed under the pUC induction conditions. When induced, by using IPTG, the enzyme activities for dihydrofolate reductase and thymidylate synthase were several-fold above control, i.e. no IPTG, activities. These facts indicate that frd and td were both cloned in the proper orientation. The construction of the recombinant was, therefore, completed and was sent to our collaborators in Albany, New York.