

AN ABSTRACT OF THE THESIS OF

Karen Illman Miller for the degree of Doctor of Philosophy in Zoology

presented on September 30, 1980.

Title: Effect of environmental variables on the structure and function  
of hemocyanin from Callianassa californiensis (Decapoda: Thalassinidea).

Redacted for Privacy

Abstract approved: \_\_\_\_\_

A.W. Pritchard

Oxygen binding behavior and subunit association-dissociation of the hemocyanin from Callianassa are sensitive to several environmental variables. Callianassa californiensis is a burrowing estuarine which must survive changes in salinity, temperature and oxygen availability. Previous work on the structure and function of the hemocyanin was done under conditions which did not duplicate physiological and environmental parameters. The present research was undertaken to define precisely what changes in oxygen binding behavior and subunit composition might occur under conditions the animal might reasonably be expected to encounter in its habitat.

A series of buffered physiological saline solutions was developed which would mimic ionic conditions in the hemolymph at a given salinity and which would allow precise control of pH at a given temperature. These buffers were used for both oxygen binding and sedimentation velocity experiments.

The first part of the thesis describes the results of oxygen binding measurements. The oxygen binding affinity of the 39S hemocyanin species drops only slightly when salinity drops from 35 o/oo to 17.5 o/oo and cooperativity is unaltered. The maximum Hill coefficient occurs at the physiological pH. The affinity of the 17S hemocyanin is similar, but the cooperativity is quite different.

The second part of the thesis is concerned with structural changes in the hemocyanin. Callianassa hemocyanin exhibits a  $Mg^{2+}$  dependent reversible monomer-tetramer subunit association. Callianassa is an osmoconformer for all major ions. The effect of salinity, temperature and protein concentration on the amount of dissociation of subunits was determined. These three variables were related by an equation which describes a surface of equal dissociation, defined as an "isolytic" surface. By using computer graphics to visualize the surface it was determined that the equation predicts quite well the dissociation which can be observed in whole blood.

The primary conclusion drawn from both lines of research is that the hemocyanin is remarkably stable, both structurally and functionally, and provides a kind of molecular homeostasis for an animal which must survive an unstable estuarine environment.

Effect of Environmental Variables on the Structure  
and Function of Hemocyanin from Callinassa  
californiensis (Decapoda: Thalassinidea)

by

Karen Illman Miller

A THESIS

submitted to

Oregon State University

in partial fulfillment of  
the requirements for the  
degree of

Doctor of Philosophy

Completed September 30, 1980

Commencement June 1981

APPROVED:

Redacted for Privacy

---

Professor of Zoology in charge of major

Redacted for Privacy

---

Chairman, Department of Zoology

Redacted for Privacy

---

Dean of Graduate School

Date thesis is presented September 30, 1980

Typed by Paula K. Sparks for Karen Illman Miller

## ACKNOWLEDGMENTS

I wish especially to thank Professor K.E. Van Holde and A.W. Pritchard for advice, support and encouragement. I also wish to acknowledge the inspiration of Dr. Charlotte Mangum, whose insistence that Callianassa was different provided the impetus for the project. Special thanks go to my husband Ed for his patience and understanding and to Kenneth, who truly understands at age four what it means for his mother to be a zoologist.

## TABLE OF CONTENTS

### PART 1. Oxygen Binding

Introduction . . . . .	1
Materials and Methods . . . . .	5
Isolation and Purification of Hemocyanin . . . . .	5
Buffer Solutions Used . . . . .	5
Mg <sup>2+</sup> Regulation . . . . .	5
Measurement of Blood pH . . . . .	6
Oxygen Binding Studies . . . . .	6
Results. . . . .	6
Discussion . . . . .	13
Figure Legends . . . . .	19
Figures . . . . .	21
References . . . . .	29

### PART 2. Subunit Association-Dissociation Behavior

Introduction . . . . .	31
Materials and Methods . . . . .	32
Preparation of Solutions . . . . .	32
Sedimentation Velocity . . . . .	34
Results . . . . .	34
Discussion . . . . .	36
Figure Legends . . . . .	43
Figures . . . . .	45
References . . . . .	53

## LIST OF FIGURES

### PART 1

<u>Figure</u>		<u>Page</u>
1	Magnesium levels in the blood at decreasing salinity	21
2	Oxygen binding curves, 100% and 50% buffered saline, 10°C.	22
3	Hill plots, 100% and 50% buffered saline, 10°C.	23
4	Bohr effect curves in 100% and 50% buffered saline, 10°C.	24
5	Relationship between affinity and cooperativity, 100% and 50% buffered saline	25
6	Oxygen binding curves and Hill plots for Hcy I	26
7	Bohr effect curves for Hcy I and Hcy C	27
8	Relationship between affinity and cooperativity for Hcy I	28

### PART 2

<u>Figure</u>		<u>Page</u>
1	Schlieren profiles of hemolymph from a shrimp acclimated to 40% seawater	45
2	Effect of salinity on amount of dissociated hemocyanin	46
3	Effect of temperature on amount of dissociated hemocyanin	47
4	Effect of protein concentration on amount of dissociated hemocyanin	48
5	Log plot of dissociation vs. salinity	49
6	Log plot of dissociation vs. temperature	50
7	Isolytic surfaces for dissociation of hemocyanin	51
8	Sections of isolytic surfaces at several temperatures, including physiological limits	52

Effect of environmental variables on the structure and function of hemocyanin from Callinassa californiensis (Decapoda: Thalassinidea)

Part I - Oxygen Binding

INTRODUCTION

Oxygen dissociation curves are the fundamental measure of molecular and physiological function in respiratory proteins. They are remarkably sensitive to changes in pH, temperature and ionic composition of the protein solution. Much is now known about oxygen binding by hemocyanins, particularly with respect to certain individual ions such as  $H^+$ ,  $Mg^{2+}$  and  $Ca^{2+}$  (Brouwer et al, 1978; Arisaka and Van Holde, 1979; Mangum, In press, a,b). However, it has often been the practice among physical biochemists and even among physiologists to examine oxygen binding under conditions far from physiological, using simplified buffer systems that contain only a few of the ions present in whole blood. Furthermore, such experiments are often done at temperatures unrelated to the ambient temperatures of invertebrates.

Recently, there have been efforts to describe the effect of some other ions, like  $Na^+$ ,  $Cl^-$ , and  $SO_4^{2-}$  on oxygen binding behavior (Brouwer et al, 1977, 1978; Mangum and Lykkeboe, 1979). It would appear from this work that total salt concentration may be physiologically important. In particular, there are reports that NaCl can either raise or lower the oxygen affinity of hemocyanins, depending on the animal (Truchot, 1975; Brouwer et al, 1978; Mangum and Lykkeboe, 1979). Nevertheless, as Mangum points out (In press,b), very little modern



work has been done on respiratory proteins under conditions in which approximately physiological blood ion levels and temperatures are maintained.

✓ Callianassa californiensis is a burrowing thalassinid shrimp inhabiting the muddy sand of estuarine beaches of western North America at tidal levels of about -1 to +5 feet. Its burrows collapse at low tide and the animal can easily be exposed at such times to the very low oxygen levels of interstitial water. According to R. Thompson and Pritchard (1967), this may be as low as 10% of air saturation. Seawater temperature ordinarily ranges from about 9° to about 14°C on the Oregon coast (Thum, 1972). Although surface water can be warmer, Callianassa, because it can burrow constantly, is probably not exposed to warmer water. At high tide the salinity of the surface water in the estuary is close to 35 o/oo (parts per thousand). However, from November through March when runoff from heavy winter rains fills the estuary, the salinity at depths where Callianassa burrows often drops below 20 o/oo with the mean salinity at about 28 o/oo (Thum, 1972).

Several aspects of the physiological response of Callianassa to its environment are well understood. The shrimp are able to regulate oxygen consumption down to an oxygen tension range of 10-20 mm Hg (R. Thompson and Pritchard, 1967; Miller et al, 1976). They have a low metabolic rate and they are remarkably resistant to anoxia under laboratory conditions and demonstrate the ability to accumulate lactate under these conditions (Pritchard and Eddy, 1979). They are osmoconformers between 25% and 125% seawater (35 o/oo = 100% S.W.) (L. Thompson and Pritchard, 1967). This fact, coupled with the pronounced variations

in salinity which the animals may experience, indicates that the hemocyanin must actually function in a varying ionic environment.

Callianassa has two hemocyanins normally present in the blood. One sediments as a 17S component in the ultracentrifuge and the other as a 39S component. The 17S component is a hexamer of polypeptide chains; the 39S component an eikosatetramer. The 39S component shows fully reversible dissociation, breaking down into four 17S subunits when  $Mg^{2+}$  is removed and reassociating when  $Mg^{2+}$  is replaced. The two 17S hemocyanins have been designated as competent (Hcy C) and incompetent (Hcy I) on the basis of their ability to form the 39S tetramer at high  $Mg^{2+}$ . The complex association-dissociation process has been thoroughly investigated in this laboratory (Roxby et al, 1974; Blair and Van Holde, 1976; Van Holde et al, 1977; Arisaka and Van Holde, 1979).

Our original work on oxygen binding by Callianassa 39S hemocyanin was done at 25°, with .05 M  $MgCl_2$  and 0.01 M  $CaCl_2$  added for the Bohr effect series and at pH 7.65 for the  $Mg^{2+}$  series (Miller and Van Holde, 1974). The temperature is far from that ever experienced by the animal, and the ionic medium certainly does not duplicate normal hemolymph. This is not to say that our conclusions concerning the allosteric behavior of Callianassa hemocyanin were invalid; merely that the values of oxygen binding affinity and cooperativity parameters measured in those early experiments could not be used to describe the physiology of the animal with any accuracy. We did approach more nearly this goal with several thalassinids (Miller et al, 1976), but we ignored the effect of total salt in these experiments.

Our interest in the effect of lowered salinity on the molecule stems from the observation of L. Thompson and Pritchard (1967) that Callianassa does not regulate ion levels in its blood when the seawater salinity drops. When this is combined with the  $Mg^{2+}$  dependence of oxygen affinity and dissociation of subunits (Roxby et al, 1974; Miller and Van Holde, 1974; Miller et al, 1976), the possibility for significant alteration of structure and function of hemocyanin becomes very real. This has been pointed out by Mangum (In press, a,b), who also proposes a theory for a process she calls "enantio-stasis" in which changes in blood pH might counterbalance changes of hemocyanin function at low salinity (Mangum, 1975, 1976; Weiland and Mangum, 1975). It seemed very worthwhile to test these hypotheses experimentally.

The present reinvestigation of the oxygen binding behavior of Callianassa hemocyanin was undertaken to answer the following questions:

- 1) What are the  $Mg^{2+}$  concentration, pH and normal hemocyanin concentrations in Callianassa hemolymph and how do they change following acclimation of animals to low salinity?
- 2) What are the effects of temperature and physiological levels of NaCl and KCl on oxygen binding?
- 3) What is the effect of lowered salinity on blood pH and oxygen binding at 10°C (normal habitat temperature)?
- 4) What, if any, differences in  $O_2$  binding can be discovered between the incompetent 17S and competent 39S hemocyanins from Callianassa? The companion paper describes the changes in protein structure observed at low salinity.

## MATERIALS AND METHODS

1. Isolation & purification of hemocyanin. Shrimp were obtained from mudflats at Newport or Waldport, Oregon. The animals were bled and the hemolymph purified on Bio-gel A5M as previously described (Roxby *et al*, 1974). Unless specified all experiments were done on 39S Hcy C.

2. Buffer solutions used. Standard column buffer (used in A5M purification) was 0.1 ionic strength Tris, prepared according to Long (1961), with the addition of 50 mM  $MgCl_2$  and 10 mM  $CaCl_2$ . Physiological saline buffers were prepared using standard 0.1 I Tris-HCl but with the addition of concentrated salt solutions. We define a "100% saline" buffer as containing 44 mM  $MgCl_2$ , 9 mM  $CaCl_2$ , 13 mM KCl and 446 mM NaCl in addition to the Tris. For lower percentage saline buffers, the Tris-HCl remained unchanged and the salt concentrations were reduced proportionately. When experiments requiring low temperatures were performed the Tris buffer was titrated up to the proper pH with 1 M Tris in a refrigerated water bath.

3.  $Mg^{2+}$  regulation. Animals were collected and placed individually in 500 ml beakers of seawater at 10° for 24 hours initially. Water was changed daily, but not aerated. After this period of adjustment the salinity of the water was reduced stepwise by 20-25% at one day intervals and held at the final salinity for three days before blood samples were taken. A salinity of 35 o/oo was used for 100% seawater, 17.5 o/oo for 50% seawater, etc. The salinity was measured using a precision hydrometer and dilutions were made with distilled water. Blood samples and bath samples were analyzed for magnesium

using a Perkin Elmer Model 403 atomic absorption spectrophotometer. Standards were prepared according to the Perkin-Elmer handbook. Protein concentration of each sample was determined by measuring absorbance at 337 nm, using an extinction coefficient at 337 nm of  $0.313 \text{ (mg/ml cm)}^{-1}$  (Roxby et al, 1974).

4. Measurement of blood pH. The Radiometer Blood Microanalyzer system was used to determine pH of blood samples taken from the abdominal sinus of animals acclimated to 50% and 100% seawater. The samples were taken anaerobically in capillary tubes, avoiding air bubbles, and the system was cooled to  $10^{\circ}$ , the acclimation temperature.

5. Oxygen binding studies. Oxygen binding curves were measured as described previously (Miller and Van Holde, 1974). After degassing by vacuum evacuation and  $\text{N}_2$  flushing until the peak at 337 nm disappeared, the hemocyanin oxygenation was measured at 337 nm as air was added in 1.18 or 0.17 ml increments. Temperature equilibration for 15 min. in a refrigerated shaker bath followed each addition. In order to prevent warming of samples and the resultant pH change of the Tris buffers during the transfer from bath to spectrophotometer, the cuvette was transferred in a flask of bath water and the spectra were taken using a temperature controlled jacketed cuvette holder. Most of the binding curves were obtained at  $10 \pm .1^{\circ}\text{C}$ , unless otherwise specified.

## RESULTS

Thompson and Pritchard (1967) did not measure  $\text{Mg}^{2+}$  when they determined the response of Callianassa to low salinity acclimation. The lack of  $\text{Mg}^{2+}$  regulation in Callianassa is demonstrated clearly in Fig. 1.

This result is in contradiction to our original assumption (Miller and Van Holde, 1974) that  $Mg^{2+}$  is regulated and does not drop as salinity decreases. Blood  $Mg^{2+}$  of Callinassa is consistently slightly hypotonic over the range 125 to 50% seawater. Below 50% seawater there is a slight rise in  $Mg^{2+}$  levels but it is not dramatic. These  $Mg^{2+}$  values, plus the values on other ions from Thompson and Pritchard (1967) were used to prepare buffered physiological salines which reflect the actual ion concentrations found in the hemolymph at different ambient salinities. For simplicity, the series of buffers were direct dilutions of our 100% physiological saline with 0.1 I Tris. This may mean that the ion levels in our buffers at 37.5% seawater and below were slightly lower in total  $Mg^{2+}$  than the actual hemolymph concentrations, but the case for regulation is not very strong, since other ions all seem to continue to drop below 50% seawater (L. Thompson and Pritchard, 1967). Similar patterns of ionic and osmotic regulation occur in several western Atlantic Callinassidae (Felder, 1978).

Hemocyanin concentrations in the blood of some of the acclimated animals are presented in Table 1. There is no clear trend of change of protein concentration at low salinity and the range of values in different animals is quite large (22 to 87.5 mg/ml). Curiously the mean protein concentrations from these shrimp seems low compared to the values of ~100 mg/ml we have observed for pooled hemolymph on other occasions. Furthermore, we seem to see lower protein concentrations in populations from Waldport and Sand Lake, Oregon than from Newport, Oregon. Ultimately all one can say is that protein concen-

trations from populations as well as individuals can vary widely.

Blood pH at 10°C for shrimp acclimated for 3 days to 100% seawater is  $8.20 \pm .09$  (6); in 50% seawater it is  $8.19 \pm .03$  (8). Thus, there is no apparent difference in pH between the two salinities. The pH of pooled blood at 20° is closer to 8.0 and at 25° it may fall as low as 7.8 (Miller et al, 1976).

The effect of NaCl and KCl on oxygen binding is to produce a slight decrease in affinity. See Table 2. There is only a slight variation in cooperativity with the Hill coefficient  $n_H$  changing from ~2.6 to ~2.9 with added salt. However the concept of cooperativity needs further discussion (see below).

The effect of temperature is to increase affinity as temperature drops. In pH 8.0, 100% saline buffer the p50 drops from 10.5 at 20°, to 7.5 at 15° to 5.7 at 10°. This is in contrast to our previous findings (Miller and Van Holde, 1974) where the minimum p50 occurred at 15° and there was a slight increase in p50 at lower temperatures. It is our belief that the increase may have been a result of the difficulty we had in obtaining precise low temperature binding curves without a water-jacketed cuvette holder in the spectrophotometer. Even slight warming would lower the pH of the Tris buffer and cause an apparent decrease in affinity. The increased affinity at low temperature is consistent with observations for other species (Mangum, In press, b). At a fixed pH of 8.0, cooperativity increases at high temperature, going from  $n \cong 2.85$  at 10° to 3.7 at 20°. However, as will be discussed later, measurements at one pH do not give a complete picture of the cooperativity.

Table 1. Hemocyanin concentration in hemolymph of Callianassa  
following acclimation to various salinities.

Salinity	35%	80%	100%	120%
Mean protein conc (mg/ml)	69.6	50.95	41.45	49.0
SD	±18.5	±16.3	±15.0	±16.91
N	(4)	(6)	(6)	(5)



Table 2. Oxygen binding properties of Hcy C at 10°C, 0.1 I Tris-HCl, pH 8.0.

Buffer salts	p50	n
100% CaCl <sub>2</sub> & MgCl <sub>2</sub>	4.5	2.56
100% CaCl <sub>2</sub> , MgCl <sub>2</sub> , KCl, NaCl	6	2.93
50% CaCl <sub>2</sub> , MgCl <sub>2</sub>	7	2.63
50% CaCl <sub>2</sub> , MgCl <sub>2</sub> , KCl, NaCl	10.5	2.67

Note: 100% and 50% refer to amounts of salts found in hemolymph of animals acclimated to 100% and 50% seawater. See Methods for precise concentrations.

The oxygen binding curves and Hill plots for 100% and 50% salinity at 10°C are presented in Figures 2 and 3. The specific values for p50 and  $n_H$  are found in Table 3. The summary curve for Bohr effect (Figure 4) shows two complex curves, distinctly different in affinity, but quite similar in shape. While the data are not complete enough to give complete assurance, they suggest a biphasic Bohr effect in both cases, meaning more than one Bohr proton is being titrated. A similar biphasic curve is revealed when the data obtained earlier in 50 mM  $Mg^{2+}$ , 10 mM  $Ca^{2+}$  are plotted (Table III, Miller et al, 1976). Decreasing salinity lowers the affinity. The steepest part of the curve is between pH 8.2 and 7.8, which spans the physiological pH range. The slope ( $\Delta \log p50 / \Delta pH$ ) in this range is -1.59, whereas the slope at lower pH is -0.90 and at higher pH it is -0.70. Figure 5 shows the relationship between affinity and the cooperativity parameter for the two series of experiments. Again we see two curves, very similar in shape, with the low salinity curve offset to lower affinity. Cooperativity maxima of about 3.5 occur in both curves at about pH 8.13, close to the physiological pH, which we measured as 8.2 at 10°.

The Bohr effect oxygen binding curves and Hill plots for the incompetent 17S hemocyanin (Hcy I) from Callianassa are presented in Figure 6. The summary curve for log p50 vs. pH (Fig. 7) shows that the affinity follows closely the curve for the competent hemocyanin (Hcy C), taken from Miller and Van Holde (1974). The binding curves for Hcy C were performed at 25° and those for Hcy I were done at 20°. The buffers for both curves were 0.1 I Tris with 50 mM  $MgCl_2$  and 10 mM  $CaCl_2$ . Had we done the Hcy C curve at 20° the affinity would

Table 3. Oxygen binding properties of Hcy C at 10°C, varying salinity and pH.

100% sal	pH	p50	log p50	$n_H$
	7.13	38.5	1.59	1.04
	7.57	14.75	1.16	1.92
	7.80	11	1.04	2.44
	8.00	6	.78	2.93
	8.13	2.5	.46	3.50
	8.40	1.5	.18	2.92
	8.73	1	<0.01	2.57
50% sal	pH	p50	log p50	$n_H$
	7.38	35	1.54	1.52
	7.57	23	1.36	1.46
	7.80	17	1.23	2.05
	8.00	10.3	1.01	2.67
	8.14	4.5	.65	3.40
	8.40	3	.48	3.23
	8.73	2	.3	-

probably have been slightly higher (lowering the temperature raises affinity). Therefore extensive comparisons based on the positions of the two curves would not be profitable. However it is clear the shapes are similar and the maximum slope, which again spans the physiological pH, is -1.1. The plots of Hill coefficient vs. affinity are very different (Fig. 7). The maximum cooperativity for both seems to occur at about pH 7.9 which is roughly the pH of whole blood measured at 20-25°. However, the incompetent hemocyanin shows much reduced cooperativity at all pH values. The magnitude and direction of the Bohr shift for the incompetent hemocyanin is thus very similar to that of the competent hemocyanin, but the molecule is clearly less cooperative in binding oxygen.

#### DISCUSSION

The results we have presented can help define the nature of alterations in oxygen binding properties of Callianassa hemocyanin with changes in salinity. There is a small loss of affinity at low salinity, but the cooperativity is not affected. The two composite Bohr effect curves for 100% and 50% seawater (Fig. 5) show a consistent difference at every pH. The blood pH at 10°C is around 8.2 which means the values for p50 (2.5 and 4.5 mm Hg at pH 8.13) are lower than we previously believed for normal physiological conditions. They are among the lowest reported for crustaceans (Mangum, In press, b). However it is known that the interstitial pO<sub>2</sub> at low tide is about 15 mm Hg (R. Thompson and Pritchard, 1967), leading to a considerably smaller pO<sub>2</sub> gradient from water to blood than would be observed with

decapods living in air saturated sea water. It is unlikely that the hemocyanin, despite its high affinity, would be fully saturated under these conditions and indeed there is some evidence that it is not (Miller et al, 1976).

The effect of low salinity on oxygen consumption patterns in Callianassa is not yet well understood. Pritchard (personal communication) reports that he has not seen any evidence for alteration of critical oxygen tension or levels of routine oxygen consumption at low salinity. The change in affinity that we see is certainly not a large one at pH 8.2. At a blood pH of 7.8 or below, we see a larger relative change in p50 from 100% to 50% seawater. Mangum (1979) supposes a drop in  $Mg^{2+}$  to less than 12.5 mM (25% seawater levels) would cause a drop in log p50 by a factor of 2, a change she feels would be difficult for Callianassa to counteract by normal ventilatory and circulatory mechanisms. However, that change was based on our data from  $O_2$  binding at pH 7.65 and 25° (Miller and Van Holde, 1974) and does not apply well to physiological conditions.

There is now no good evidence for the kind of increase in  $O_2$  consumption postulated by Mangum (1976) as a passive consequence (i.e., without considering the possibility of other compensatory ventilation or circulation changes) of the altered ionic environment in which the respiratory pigment operates. We must for now assume that Callianassa is able to compensate for the change in affinity at least down to 50% seawater. This compensation is probably not due to an increase in blood pH, the process Mangum (1976) calls "enantiostasis", since we observe no change in pH in the blood of animals acclimated to low

salinity. It is more likely to result from ventilation and circulation changes. It would be particularly interesting to see whether animals with lower hemocyanin concentrations in the blood have different patterns or rates of ventilation etc., since although the oxygen binding behavior of the hemocyanin may not change the oxygen carrying capacity of the blood (and hence the ability to extract oxygen) would depend on protein concentration.

As for more extreme salinities, we know that Callianassa can survive three days of acclimation to 25‰ seawater (although our experience shows somewhat more mortality at these salinities than in 50-100‰ seawater). What we know about the specific habitat of Callianassa at Newport indicates that it is unlikely to experience any prolonged exposure to salinities less than 50‰ seawater (17 o/oo) (Thum, 1972). Furthermore, if indeed very low salinity brings about some measure of respiratory distress, the animal is well able to cope with the anaerobic metabolism that would result (Pritchard and Eddy, 1979).

The function of the incompetent hemocyanin from Callianassa is not yet clear. Since the affinity seems close to the competent hemocyanin under similar conditions, but the cooperativity is considerably less, one might propose that the HcyI is unloading its oxygen to HcyC at the gill and picking up oxygen from HcyC in the tissues. It is difficult to see what advantage this would be to the organism. The possibility still remains that it is not a separate and essential respiratory protein, but some kind of breakdown product, or the consequence of an "incorrect" assembly of subunits. The fact that it is present in

varying amounts in different animals, and gives more small molecular weight bands on SDS gels (Roxby et al, 1974) might support the former idea.

It is necessary at this point to consider the cooperativity of this hemocyanin in more detail. The most striking feature of the curves in Figures 5 and 8 is that for hemocyanin C all are of the same shape and height. The shape of this curve depends on four parameters: the intrinsic affinity constants for the high and low affinity forms of the molecule  $k_R$  and  $k_T$ , (or, alternatively,  $k_R$  and  $c$  where  $c = k_T/k_R$ , the nonexclusive binding constant); a parameter describing the relative abundance of hybrid states,  $q$ ; and the number of sites in the allosteric unit,  $n$ . The theory describing this relationship has been covered extensively by Miller and Van Holde (1974) and Arisaka and Van Holde (1979) and will not be repeated here. However the critical fact is that to get a curve shifted to right or left, but unaltered in shape and height,  $n$ ,  $q$ , and  $c$  must be unchanged. Therefore  $k_R$  and  $k_T$  must change together in such a way that the value of  $c$  is the same. In other words, only affinity changes in response to temperature and salinity, and the intrinsic affinities of both allosteric states change in concert, preserving the shape of the curve. The cooperativity of the molecule in its most fundamental sense - the number of sites in the unit and how they interact - is unaltered. A second important result is that the Bohr effect appears to compensate for changes in blood pH with temperature so that the maxima in Fig. 5 and 8 always occur at the actual pH of the blood.

The incompetent hemocyanin shows a very different response. The span of the curve appears to be narrower, meaning  $c$  is smaller and very likely  $q$  and perhaps even  $n$  are also altered. The simplest explanation might be that  $k_T$ , the low affinity binding constant, is the same and the molecule is somehow constrained from forming the high affinity R state, meaning  $k_R$  is lower; but the situation may be considerably more complex.

From a purely practical standpoint, one must exercise great care in comparing results simply on the basis of  $n_H$ , since this parameter can depend so much on specific experimental conditions. To say for example that the cooperativity of the hemocyanin is greater at one salinity or another is potentially misleading, since it depends at which end of the curve (Fig. 5) the experimental pH lies. Furthermore, it is critical to know the blood pH at a given temperature.

These results indicate a remarkably homeostatic kind of response. Homeostasis as it is often used implies elaborate interacting systems like those seen in vertebrates which produce a constant internal environment, and thus maintain constant physiological function for many environmentally sensitive enzymes (and respiratory proteins). The ultimate product of such systems is stability of function. In Callianassa stability of function results directly from changes occurring at the molecular level in the respiratory protein itself. The hemocyanin displays almost total stability of molecular cooperativity, despite changes in salinity and temperature. It has only a small alteration of affinity at normal blood pH, even when the salinity drops dramatically. And yet it remains sensitive to changes in blood pH with



temperature so that maximum cooperativity is always maintained. Thus stability of function is the primary characteristic of a molecule obtained from an animal which must survive the considerable variability of the estuarine environment.

## FIGURE LEGENDS

Figure 1. Magnesium in the blood of Callianassa as a function of medium magnesium concentration. Points are the averages of duplicate determinations. Symbols represent experiments run at different times.

Figure 2A. Oxygen binding by Callianassa 39S hemocyanin C in 100% buffered saline, 10°C.

2B. Oxygen binding by Callianassa 39S hemocyanin C in 50% buffered saline, 10°C. The pH is indicated for each curve.

Figure 3A. Hill plots of oxygen binding curves in Figure 2A.

3B. Hill plots of oxygen binding curves in Figure 2B. The pH is indicated for each curve.

Figure 4. Log p50 as a function of pH for Callianassa 39S hemocyanin C.

⊙ 100% buffered saline, 10°C

⊠ 50% buffered saline, 10°C

Figure 5. Hill coefficient as a function of log p50 over the pH range 8.7 to 7.1

●—● 100% buffered saline, 10°C

⊠—⊠ 50% buffered saline, 10°C

--- in .1 I Tris, .05 M Mg<sup>2+</sup>, .01 M Ca<sup>2+</sup>, 25°C (from Miller & Van Holde, 1974). The pH of the maximum is indicated for each curve by the arrow. (The pH values for each point are found in Table 3).

Figure 6A. Oxygen binding by Callianassa Hcy I in .1 I Tris with 100%  $\text{Ca}^{2+}$  and  $\text{Mg}^{2+}$ , 20°C.

6B. Hill plots of oxygen binding curves in 6A. The pH is indicated for each curve.

Figure 7. Log p50 as a function of pH for Callianassa hemocyanin I and C

✕ Hcy I in .05 M  $\text{Mg}^{+2}$ , .01 M  $\text{Ca}^{+2}$ , 20°

● Hcy C in .05 M  $\text{Mg}^{+2}$ , .01 M  $\text{Ca}^{+2}$ , 25° (from Miller and Van Holde, 1974)

Figure 8. Hill coefficient as a function of log p50 for Callianassa hemocyanin I and C, over the pH range 8.8 to 7.1.

✕→ Hcy I in .05 M  $\text{Mg}^{+2}$ , .01 M  $\text{Ca}^{+2}$ , 20°

---- Hcy C in .05 M  $\text{Mg}^{+2}$ , .01 M  $\text{Ca}^{+2}$ , 25°

(from Miller and Van Holde, 1974)

The pH of the maximum for each curve is indicated by the arrow.

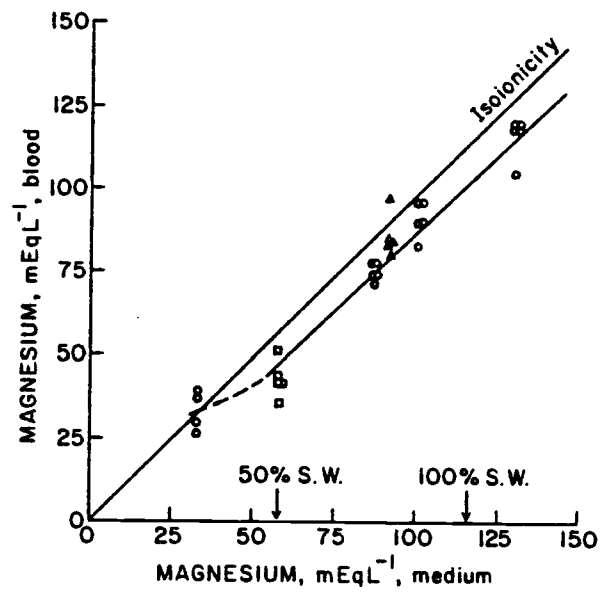

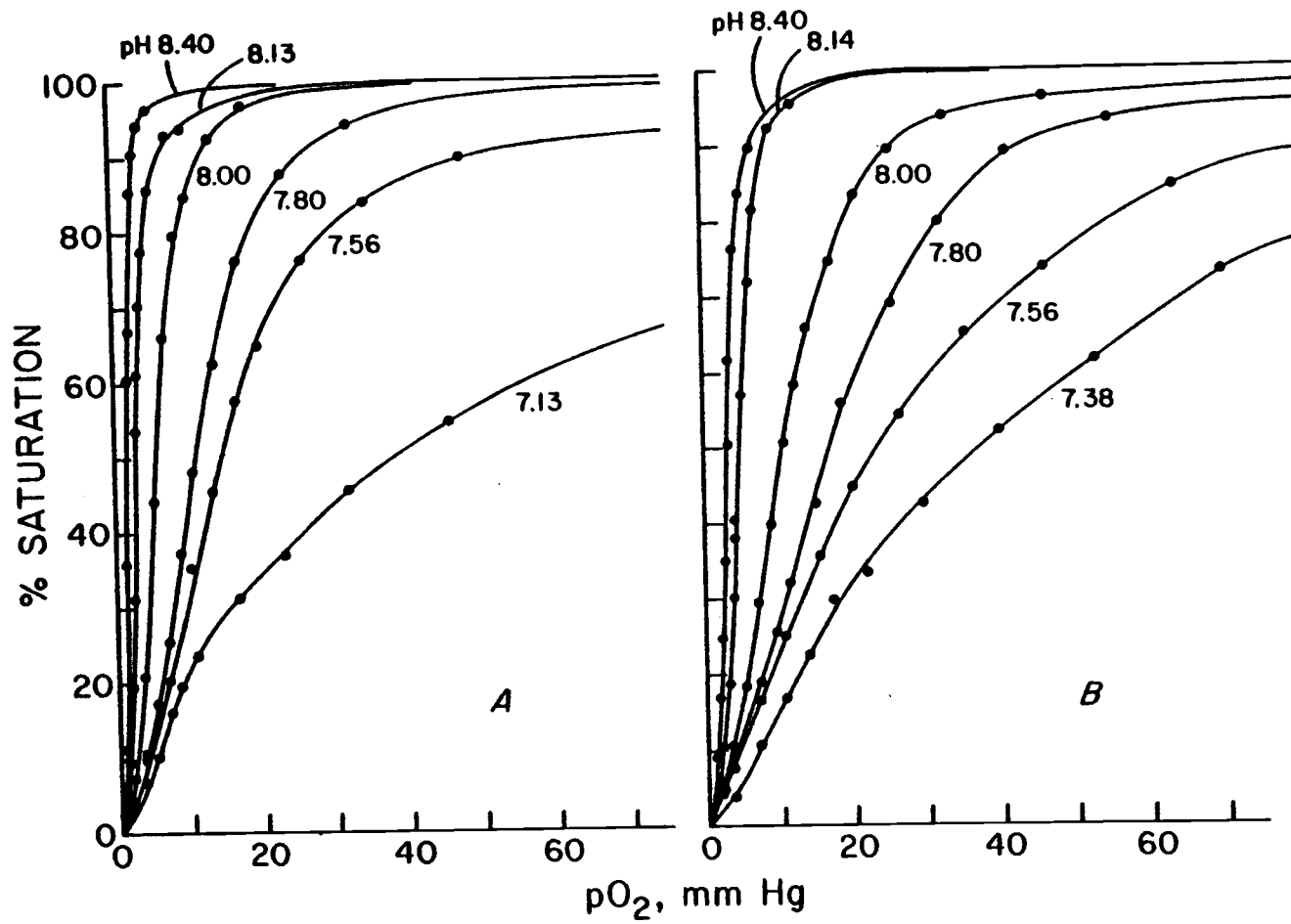

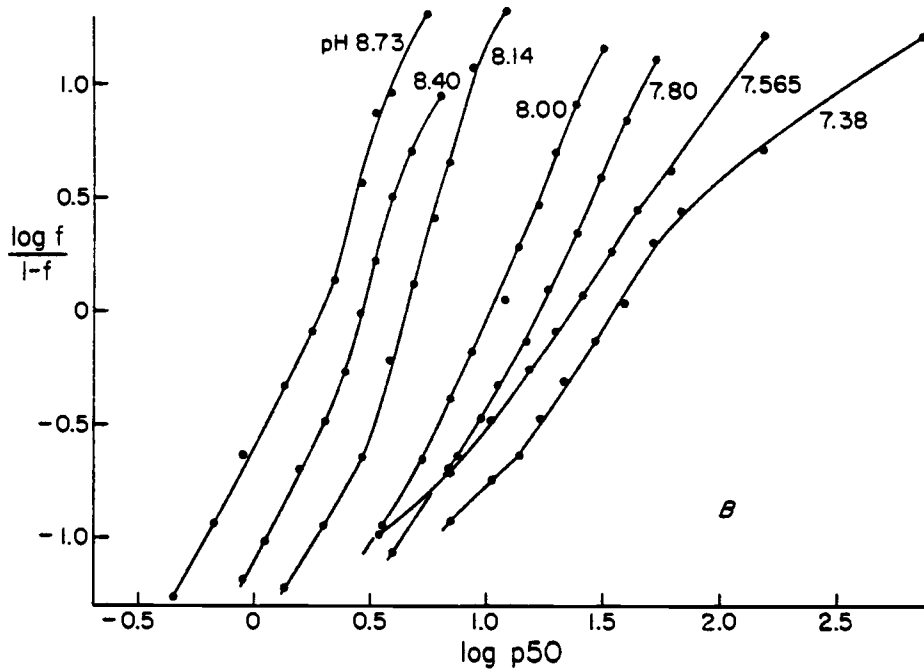
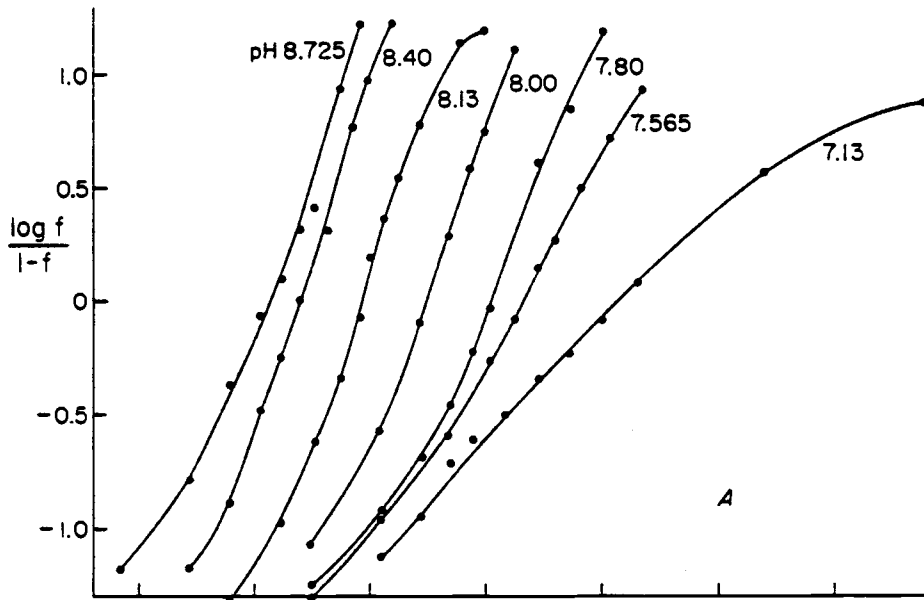

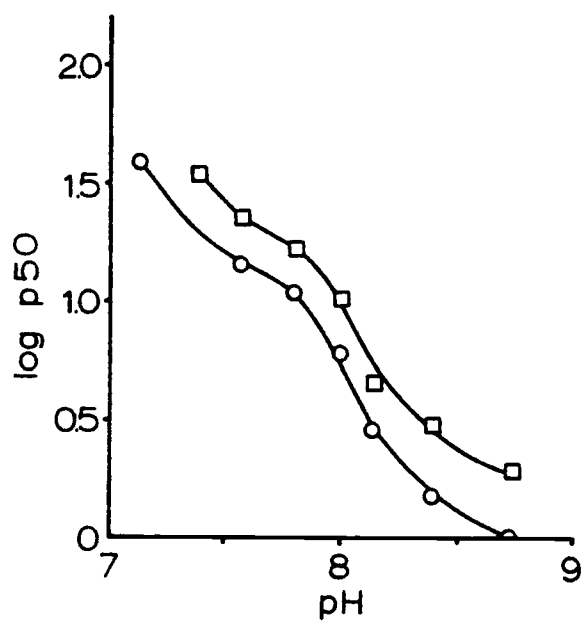

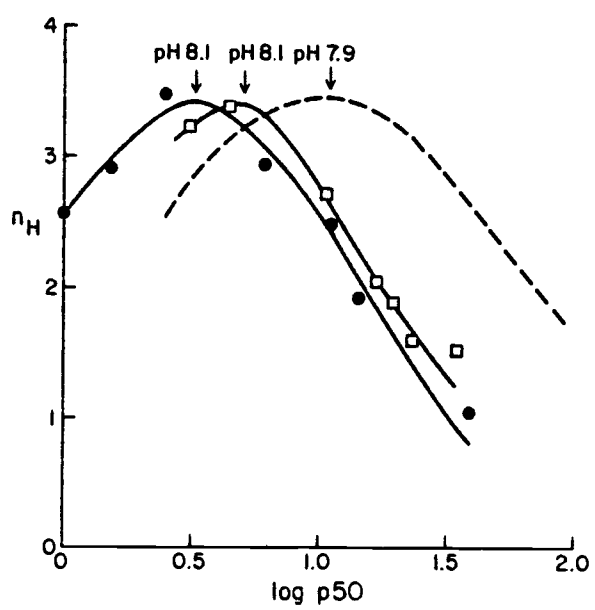



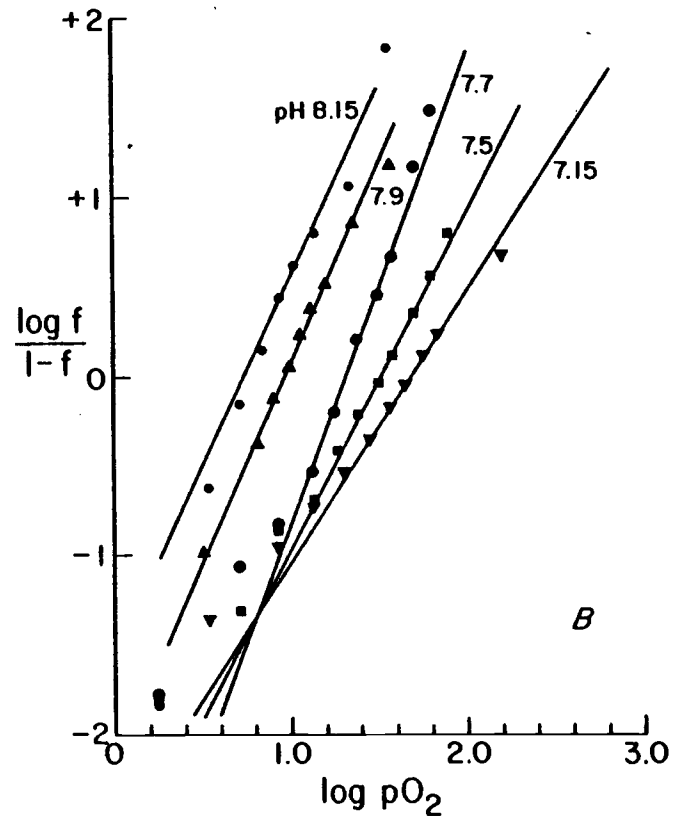
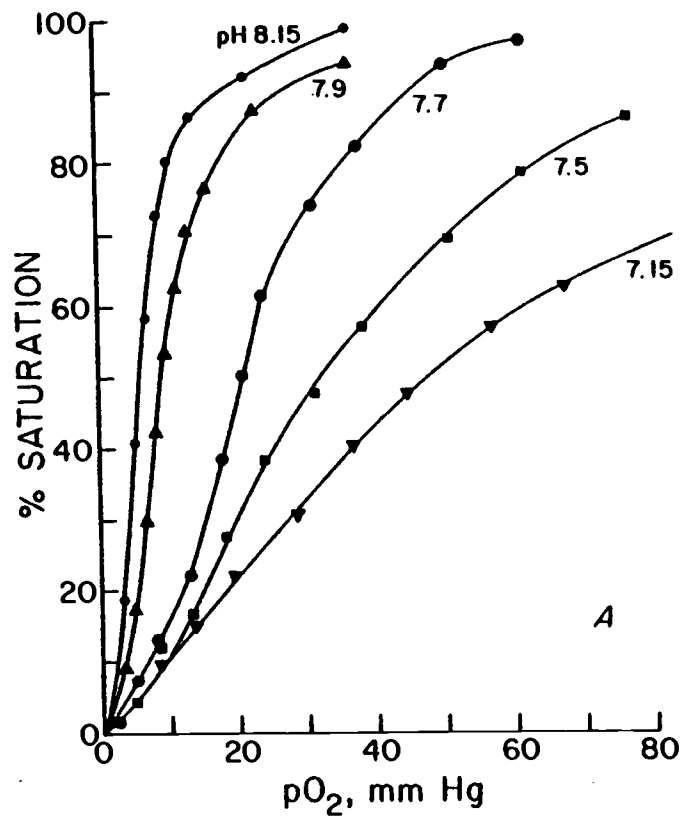

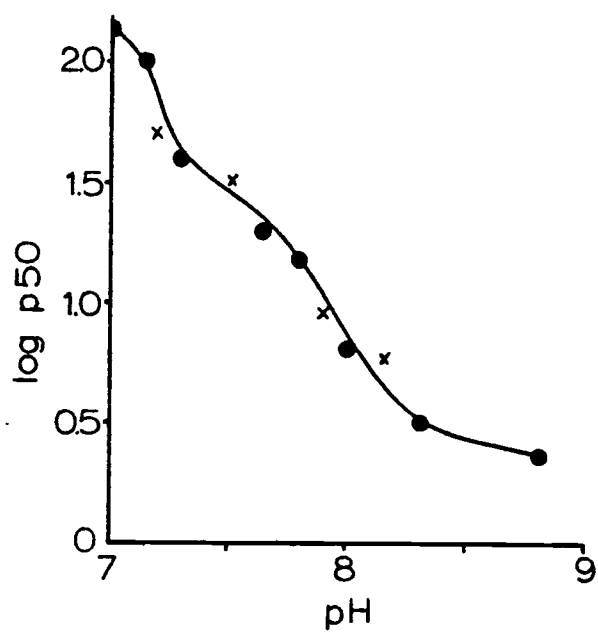

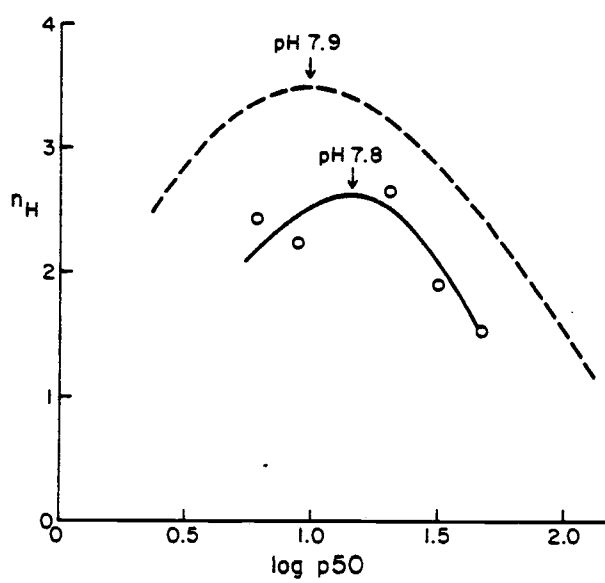

## REFERENCES

- Arisaka, F., Van Holde, K.E.: Allosteric properties and the association equilibria of hemocyanin from Callianassa californiensis. J. Mol. Biol. 134, 41-73 (1979)
- Blair, D., Van Holde, K.E.: Sedimentation equilibrium studies of a complex association reaction. Biophys. Chem. 5, 165-170 (1976)
- Brouwer, M., Bonaventura, C., Bonaventura, J.: Oxygen binding by Limulus polyphemus hemocyanin: Allosteric modulation by chloride ions. Biochem. 16, 3897-3902 (1977)
- Brouwer, M., Bonaventura, C., Bonaventura, J.: Analysis of the effect of three different allosteric ligands on oxygen binding by hemocyanin of the shrimp, Penaeus setiferus. Biochem. 17, 2148-2154 (1978)
- Felder, D.L.: Osmotic and ionic regulation in several western Atlantic Callianassidae (Crustacea, Decapoda, Thalassinidea). Biol. Bull. 154, 409-429 (1978)
- Long, C. (Ed.): Biochemists Handbook. p. 28. Princeton, N.J.: Van Nostrand 1961
- Mangum, C.P.: The function of respiratory pigments in estuarine animals. In: Estuarine Processes, Vol. I. New York: Academic Press 1976
- Mangum, C.P.: The influence of inorganic ions and pH on HCO<sub>2</sub> transport systems. In: Invertebrate Oxygen Binding Proteins. Lamy, J., Lamy, J., (Eds.) New York: Marcel Dekker (In press, a)
- Mangum, C.P.: Oxygen transport in the blood. In: Biology of Crustacea, Vol. II. Mantel, L.H. (Ed). New York: Academic Press (In press, b)
- Mangum, C.P., Lykkeboe, G.: The influence of inorganic ions and pH on oxygenation properties of the blood in the gastropod mollusc Busycon canaliculatum. J. Exp. Zool. 207, 417-430 (1979)
- Mangum, C.P., Towle, D.W.: Physiological adaptation to unstable environments. Amer. Scient. 65, 67-75 (1977).
- Miller, K., Van Holde, K.E.: Oxygen binding by Callianassa californiensis hemocyanin. Biochem. 13, 1668-1674 (1974)
- Miller, K.I., Pritchard, A.W., Rutledge, P.S.: Respiratory regulation and the role of the blood in the burrowing shrimp Callianassa californiensis (Decapoda:Thalassinidea). Mar. Biol. 36, 233-242 (1976)
- Miller, K.I., Eldred, N.W., Arisaka, F., Van Holde, K.E.: Structure and function of hemocyanin from thalassinid shrimp. J. Comp. Physiol. 115, 171-184 (1977)

- Pritchard, A.W., Eddy, S.: Lactate formation in Callianassa californiensis and Upogebia pugettensis (Crustacea:Thalassinidea). Mar. Biol. 50, 249-253 (1979)
- Roxby, R., Miller, K., Blair, D.P., Van Holde, K.E.: Subunits and Association equilibria of Callianassa californiensis hemocyanin. Biochem. 13, 1662-1668 (1974)
- Thompson, L.C., Pritchard, A.W.: Osmoregulatory capacities of Callianassa and Upogebia (Crustacea:Thalassinidea) Biol. Bull. 136, 114-129 (1969).
- Thompson, R.K., Pritchard, A.W.: Respiratory adaptations of two burrowing crustaceans, Callianassa californiensis and Upogebia pugettensis (Decapoda:Thalassinidea) Biol. Bull. 136, 274-287 (1969).
- Van Holde, K.E., Blair, D., Eldred, N., Arisaka, F.: Association equilibria of Callianassa hemocyanin. In: Structure and Function of Haemocyanin, Bannister, J.V. (Ed.). Berlin-Heidelberg: Springer-Verlag (1977)
- Thum, A.B.: An ecological study of Diatomovora amoena, an interstitial Acoel flatworm, in an estuarine mudflat on the central coast of Oregon. Ph.D. thesis, Oregon State University (1972)
- Weiland, A.L., Mangum, C.P.: The influence of environmental salinity on hemocyanin function in the blue crab, Callinectes sapidus. J. Exp. Zool. 193, 265-273 (1975)
- Truchot, J.-P.: Factors controlling the in vitro and in vivo oxygen affinity of the hemocyanin in the crab Carcinus maenas (L.). Resp. Physiol. 24, 173-187 (1975)

## Part II - Subunit Association-Dissociation Behavior

## INTRODUCTION

The 39S hemocyanin from the ghost shrimp Callinassa californiensis is capable of a completely reversible monomer-tetramer association. The "monomers" are in fact hexamers of polypeptide chains; the "tetramers" are eikosatetramers of these chains. The association behavior has been described thoroughly (Roxby et al, 1974; Blair and Van Holde, 1976; Van Holde et al, 1977; Arisaka and Van Holde, 1979). However, this process has been studied primarily in dilute solutions where dissociation is enhanced. It has been our assumption that considering aggregation behavior under these conditions would be of limited usefulness when applied directly to in vivo conditions, since ordinarily one would expect the higher protein concentrations of whole hemolymph to prevent the full extent of dissociation one sees in dilute solutions.

The association-dissociation equilibrium is sensitive to divalent cation concentration (Roxby et al, 1974). Callinassa does not regulate the ions in its blood as ambient salinity of the seawater drops (L. Thompson and Pritchard, 1969; Miller and Van Holde, 1981), therefore divalent cation levels in hemolymph drop. High protein concentration may not be sufficient to prevent dissociation in this situation. The intent of this work was to examine the hemocyanin again to see whether we could find evidence for dissociation at the protein concentrations of whole hemolymph and under conditions of salinity and temperature actually encountered in the environment of

this burrowing animal. The companion paper describes these conditions in more detail (Miller and Van Holde, 1981).

In this paper we report the dissociation behavior of the 39S hemocyanin from Callianassa both as purified protein and in whole hemolymph from animals acclimated to low salinity seawater. From these experiments an equation has been developed to describe the extent of dissociation as a function of salinity, temperature and protein concentration. This equation can be used to predict how much dissociation takes place under physiological conditions. We are therefore able to consider the complex relationship between several variables and evaluate the possibility, as Mangum has suggested (In press, a,b) that in Callianassa low salinity brings about significant alteration not only of hemocyanin function but of protein structure as well.

#### MATERIALS AND METHODS

##### Preparation of solutions

Animals were collected at Yaquina Bay, bled, and the blood was purified on a Bio-Gel A5M column as described previously (Roxby et al, 1974). The column buffer was 0.1 I Tris (pH 7.8) with 50 mM MgCl<sub>2</sub> and 10 mM CaCl<sub>2</sub>. This process separates the 39S "competent" hemocyanin C from a 17S "incompetent" hemocyanin I which is unable to enter into the monomer-tetramer equilibrium. Pooled 39S hemocyanin was dialyzed for 12 hr against physiological saline buffers prepared as described previously (Miller and Van Holde, 1981). These buffers were titrated as precisely as possible to pH 8.0 at the experimental temperature. When concentrated purified hemocyanin was required, we

packed the dialysis bag in crystalline sucrose until the contents were slightly more concentrated than we required, dialyzed versus the appropriate buffer, and diluted just before the experiment to the precise concentration required.

Whole blood from individual animals acclimated to low salinity seawater (Miller and Van Holde, 1981) was split into two portions. One half was loaded directly into the ultracentrifuge cell. The other half was dialyzed against 0.1 I Tris with 0.05 M  $Mg^{2+}$ , 0.01 M  $Ca^{2+}$  (pH 7.8, 20°C) before loading. The higher temperature was chosen to enhance tetramer formation. The relative amounts of monomer and tetramer for the two samples could then be compared, in order to determine the amount of 17S hemocyanin I that was normally present, (see Roxby et al, 1974; Miller and Van Holde, 1981) and the amount of 17S hemocyanin C that resulted from the lowered salinity. During the time of the experiment we expect little if any proteolysis in whole blood, based on evidence from gel electrophoresis (K. Miller, unpublished results). (Note: In all cases where we refer to salinity of seawater, 100% is equivalent to 35 o/oo (parts per thousand), 50% to 17.5 o/oo, etc. When the term is used to describe buffered physiological saline, 100% refers to the particular ion concentrations found in hemolymph from animals acclimated to 35 o/oo seawater, and 50% to half those concentrations, etc. Since Callianassa does not regulate the ions in its blood (L. Thompson and Pritchard, 1969), the actual salt levels in hemolymph are nearly the same as seawater in any case, so the terms are almost interchangeable.)



### Sedimentation velocity

All experiments in this study were performed using a Spinco Model E analytical ultracentrifuge, equipped with both Schlieren optics and photoelectric scanner. For very concentrated hemolymph samples (>25 mg/ml), we used a 3 mm cell and Schlieren optics. We began by sedimenting the sample at 30,000 rpm until the two peaks (for monomer and tetramer) were well separated, then reduced the speed to 8,000 rpm. This allowed the very sharp boundaries to diffuse enough so that the area under each peak could be measured. These areas were corrected for radial dilution and for the Johnson-Ogston effect (Schachman, 1959). Experiments at lower concentrations were performed in 12 mm cells using the scanner system and relative amounts of the two components were obtained from the absorbances of the plateau regions on the scanner traces, corrected for radial dilution. Under these conditions, the Johnson-Ogston corrections become negligible.

### RESULTS

We have good evidence that dissociation can occur in whole blood from animals held at low salinity. Figure 1 shows tracings from Schlieren profiles of hemolymph from a single shrimp, acclimated to 40‰ seawater. This particular sample had 25 mg/ml protein. The amount of monomer from the low salinity blood was 30.3%. The same blood at high salinity had 20.6% monomer, presumably all HcyI. Thus 12.5% of the HcyC had dissociated. Other runs gave somewhat lower amounts of monomer due to dissociation (for example, 50‰ seawater, 50 mg/ml showed, not surprisingly, only 1.8% increased monomer). An interesting obser-

vation from these experiments was that the amount of HcyI varies among individuals from 12% to 25% of total protein. The fact that we could demonstrate the dissociation of Callianassa hemocyanin in whole blood was interesting, but examining the process in detail in order to determine the relationship between the several variables which influence dissociation would have been extremely difficult using whole blood. Therefore we used purified 39S hemocyanin for the remaining experiments. By using the physiological saline buffers developed for oxygen binding work (Miller and Van Holde, 1981), we were able to control salinity and pH precisely, and yet know that we were approaching physiological conditions (for the major ions at least).

The effect of lowered salinity on the amount of dissociation can be seen in Figure 2. This experiment was performed at two different protein concentrations, at pH 8.0 and 20°C. There is the expected increase in the extent of dissociation at 3 mg/ml, compared to 15 mg/ml, but otherwise the two curves are similar.

Figure 3 depicts the effect of temperature on the extent of dissociation, again at pH 8.0, this time with 50% buffered saline and a protein concentration of 2 mg/ml. The graph shows a clear trend to greater dissociation at low temperature. This is consistent with the results of Blair and Van Holde (1976). The two points at 5°C represent the amount of dissociation found when the material was dialyzed at 20° (upper point) or at 3° (lower point), then equilibrated for 2 hr at 5° before the run. These values probably approach the limits of variability, so the curve is plotted midway between them.

A check was made on the  $S_{20,w}$  of the low molecular weight compo-

ment at pH 8, 5° and it was clearly all monomer. This phenomenon is interesting because Blair and Van Holde (1976) found good evidence of dimer formation at 5°C using pH 7.65 buffers. Our observation was that at pH 7.8 the low molecular weight boundary was a mixture of monomer and dimer. Furthermore, at pH 7.8 many boundaries in low salinity and/or low temperature were not sharp, or appeared to be equilibrating mixtures without any boundaries, but all boundaries were sharp and well resolved at pH 8.0.

The concentration effect (50% buffered saline, 10°C) is presented in Figure 4, showing an increase in dissociation that is dramatic below 25 mg/ml. The smooth curve is calculated for a monomer-tetramer equilibrium. Although agreement is not especially good at the highest concentration (where errors are likely to be greatest) we feel that use of this formulation is justified on the basis of a number of earlier studies (Blair and Van Holde, 1976; Arisaka and Van Holde, 1979).

#### DISCUSSION

We have demonstrated that three factors influence the amount of dissociation of the 39S Callianassa hemocyanin tetramer into monomers at a given pH: salinity, temperature, and protein concentration. However, for the purpose of considering to what extent dissociation can take place under actual physiological and environmental conditions we need an equation which will take a particular set of conditions and yield a prediction of the amount of dissociation.

Since these three variables all affect the equilibrium constant for the tetramer to monomer conversion, we can start by representing the equation simply as:

$$(1) \quad K = \frac{C_T}{C_M^4} \quad \text{where } C_T = \text{conc. tetramer}$$

$$C_M = \text{conc. monomer}$$

We will use  $\alpha$  to represent the fraction tetramer (Arisaka and Van Holde, 1979) so that:

$$(2a) \quad C_T = \alpha C_O \quad \text{where } C_O = \text{initial protein concentration}$$

and

$$(2b) \quad C_M = (1-\alpha)C_O$$

The equilibrium reaction can now be written:

$$(3) \quad K = \frac{\alpha C_O}{(1-\alpha)^4 C_O^4} = \frac{1}{C_O^3} \frac{\alpha}{(1-\alpha)^4}.$$

By rearranging and taking the natural log of each side:

$$(4) \quad \ln \frac{\alpha}{(1-\alpha)^4} = 3 \ln C_O + \ln K.$$

K as we have expressed it is not a true equilibrium constant in one sense, because dissociation depends partly on salinity, and the specific value of K should thus depend on the experimental conditions. Since the association has been shown to be mediated by a number of ion ligands (Roxby et al, 1974; Arisaka and Van Holde, 1980), we should write the reaction as:

(5)  $4 M + mX \rightleftharpoons T$  where X is the particular ligand(s) involved.

While this undoubtedly oversimplifies what must be a set of complex equilibria, it can serve as a first approximation. Furthermore, since the concentrations of the ionic ligands should be, under the conditions we have defined, proportional to the total salinity (S), we can write a new equilibrium constant:

$$(6) \quad K' = \frac{C_T}{C_M^4 S^m} .$$

Solving as before we find

$$(7) \quad K' S^m = \frac{C_T}{C_M^4} = \frac{1}{C_O^3} \frac{\alpha}{(1-\alpha)^4} .$$

So equation (4) now becomes

$$(8) \quad \ln \frac{\alpha}{(1-\alpha)^4} = 3 \ln C_O + m \ln S + \ln K' .$$

This factors out a term for salinity and leaves us with K' as a true equilibrium constant which should be independent of salinity. Then  $\ln K'$  should depend in the usual way on free energy ( $\Delta G^\circ$ ) and temperature

$$(9) \quad \ln K' = \frac{-\Delta G^\circ}{RT} = \frac{-\Delta H^\circ + T\Delta S^\circ}{RT} .$$

We can make the usual assumption that  $\Delta H^\circ$  and  $\Delta S^\circ$  should be independent of temperature so they too can be replaced by constants, leaving us with the following relationship:

$$(10) \quad \ln \frac{\alpha}{(1-\alpha)^4} = 3 \ln C_O + m \ln S + \frac{A}{T} + B .$$

Then the necessary coefficients are simply  $m$  (the slope of a plot of  $\ln \frac{\alpha}{(1-\alpha)^4}$  vs.  $\ln S$ ),  $A$  (the slope of a plot of  $\ln \frac{\alpha}{(1-\alpha)^4}$  vs.  $\frac{1}{T}$ ), and

$B$ , which can be obtained by taking the values of  $C_o$ ,  $S$ ,  $T$  and

$\ln \frac{\alpha}{(1-\alpha)^4}$  for experimental data points and solving for  $B$ .

This approach is only an approximation, but the analysis is vindicated to some extent by the fact that plotting the data in this way yields good straight lines. The value of  $A$  from Figure 5 is  $11.0 \times 10^3$ . Also two different protein concentrations give essentially parallel lines for  $\ln S$  vs.  $\ln \frac{\alpha}{(1-\alpha)^4}$  (Fig. 6). The mean slope of these lines is 8.42. The distance between them is not perfectly predicted by the equation so we presume that the equation may be only semi-quantitative with respect to concentration dependence.

A value of  $B = -11.57$  was obtained from a point in the salinity series which fell directly on the slope line. Our working equation thus becomes:

$$\ln \frac{\alpha}{(1-\alpha)^4} = 3 \ln C_o + 8.42 \ln S + \frac{11.0 \times 10^3}{T} - 11.57.$$

Having arrived at an equation defining the interrelationship between the three variables affecting dissociation of Callianassa hemocyanin, the answer to our question concerning the extent of dissociation under physiological conditions is still not intuitively obvious. The equation will define for a given  $\alpha$  a surface which is a function of the three independent variables: salinity, temperature, and concentration. Since this is a surface along which there is equal dissocia-

tion under varying conditions, we shall refer to it as an isolytic surface (Gk. isos (equal), lysos (to split)). In order to visualize the isolytic surfaces, we employed computer graphic techniques. The computer plots of the surface defined by equation 11 were obtained by fixing a value for  $\alpha$ , rewriting the equation in the form  $C = f(S, T)$  and solving for C, letting S and T range. The resulting matrices were used to generate the 3-dimensional graphs in Fig. 7. By taking sections through this volume at 5°C temperature intervals we obtained the curves in Fig. 8. The smaller rectangle within each graph in Fig. 8 defines the physiological extremes the animal might reasonably be expected to encounter (Miller and Van Holde, 1981). Three values of  $\alpha$  are included in each section, corresponding to 10% dissociation ( $\alpha = .9$ ), 25% dissociation ( $\alpha = .75$ ) and 50% dissociation ( $\alpha = .5$ ). All combinations of protein concentration and salinity to the lower left of the curves in Fig. 8 (underneath the isolytic surface in the three dimensional plots of Fig. 7) would be expected to produce dissociation at least to the extent of the given  $\alpha$ . It is immediately obvious that this model predicts some dissociation under physiological conditions, as indeed we have already observed (Fig. 1).

This model may not be totally accurate. It seems to be predicting somewhat more dissociation than we observed in whole hemolymph. However, the dissociation process is pH sensitive as well and we do not know whether the pH of the unbuffered blood was exactly pH 8.0. If it were higher, and it could easily have been (Miller and Van Holde, 1981), dissociation might have been inhibited to some extent. However, several important observations can be made. Let us consider for

example, the curve for  $\alpha = .90$  at  $10^{\circ}\text{C}$ . What we see is that salinity seems to be a somewhat more important factor in influencing the amount of dissociation than protein concentration. The shape of the curve is such that within a fairly narrow salinity range, but below a critical salinity, dissociation will be occurring at almost all protein levels. It is also clear that dissociation is never likely to be extensive under physiological conditions. If we consider the fact that the mean winter-time salinity is about 80‰ seawater and seldom drops below 50 or 60‰ (Thum, 1972), then animals with hemocyanin concentrations above 50 mg/ml for example would not experience even as much as 10% dissociation. However, our earlier data on protein concentrations in hemolymph (Miller and Van Holde, 1981) indicate that some animals will experience this much dissociation and some will not, so the entire population is not experiencing the same effects. Furthermore, when one considers 5% dissociation or less, it is easy to see that many animals will be involved.

The primary question behind this consideration of how much dissociation goes on is really very simple to ask, but not at all easy to answer. Now that we know dissociation can occur, and does occur, is it harmful or beneficial to the animal? If one assumes that aggregation state and oxygen binding behavior are linked in some way, then it would appear to be detrimental. But Arisaka and Van Holde (1979) have demonstrated that while a change in oxygenation can bring about a significant alteration of aggregation state, the converse is not true. The kinds of changes in aggregation state we observe will produce only small alterations in  $\text{O}_2$  binding behavior. Therefore dissociation



caused by lowered salinity is not substantially altering the function of the molecule. The amount of cooperativity that one sees is due to the properties of the monomer and the drop in affinity one sees in low  $Mg^{2+}$  is related to the  $Mg^{2+}$ , but is not a result of any dissociation that may be taking place.

What else could salinity-linked dissociation be doing? To some extent, the dissociation may be relieving the osmotic stress of low salinity by increasing colloidal osmotic pressure, since for each tetramer dissociating four monomers are produced. The process would certainly not be as extensive as the production of free amino acids to counteract stress, a well documented process in other invertebrates (Prosser, 1973; Wieland and Mangum, 1975; Mangum, 1977) but thus far not in Callianassa. Other effects of dissociation, if any, are yet to be discovered. Although the molecule functions primarily in the associated state, we know that some dissociation takes place, and that it probably affects the members of the population unequally insofar as they have differing hemocyanin concentrations in the blood. Thus dissociation may well produce some kind of selective pressure which helps determine the range of habitats available to Callianassa.

## FIGURE LEGENDS

Figure 1. Tracings of Schlieren photographs for the blood of a single

Callianassa with 25 mg/ml hemocyanin concentration.

\_\_\_\_\_ acclimated to 40% seawater, 10°C

- - - acclimated to 40% seawater, 10°C then dialyzed overnight vs. 0.1 I Tris, pH 7.8 with .05 M Mg<sup>2+</sup>, .01 M Ca<sup>2+</sup> at 20°C, run at 20°C. (The two photographs were not taken at the same time during the run, hence the peaks do not superimpose).

Figure 2. Percent high molecular weight hemocyanin (39S) as a function of salinity, pH 8.0 at 20°.

⊙ 3 mg/ml    □ 15 mg/ml

Figure 3. Percent high molecular weight hemocyanin (39S) as a function of temperature, 50% buffered saline, 2 mg/ml.

Figure 4. Percent high molecular weight hemocyanin (39S) as a function of hemocyanin concentration, 50% buffered saline, pH 8 at 10°C. The curve drawn in is calculated according to a monomer-tetramer equilibrium.

Figure 5.  $\text{Ln} \frac{\alpha}{(1-\alpha)^4}$  as a function of  $1/T$  absolute.

Figure 6.  $\text{Ln} \frac{\alpha}{(1-\alpha)^4}$  as a function of  $\ln$  salinity (in mEq cations).

⊙ 3 mg/ml    □ 15 mg/ml

Figure 7. Isolytic surfaces for four levels of dissociation. The dotted line marks the true bottom of the volume with dimensions: concentration 0 to 215 mg/ml, salinity 56.5 to 565 mEq cations, and temperature 273 to 298°K.

Figure 8. Sections of the isolytic surfaces at four temperatures. The dissociation levels indicated are ■ -50%, ▲ -25%, and ◆ -10%. In the section for 10°C, ● -5% and ✕ -2% have been added. The smaller box indicates physiological and environmental limits of protein concentration and salinity.

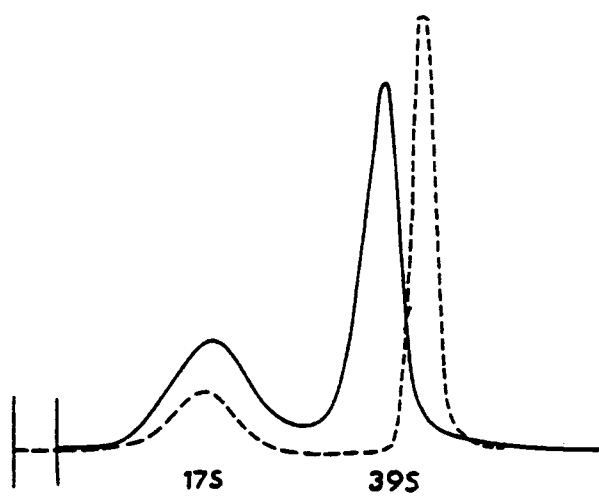

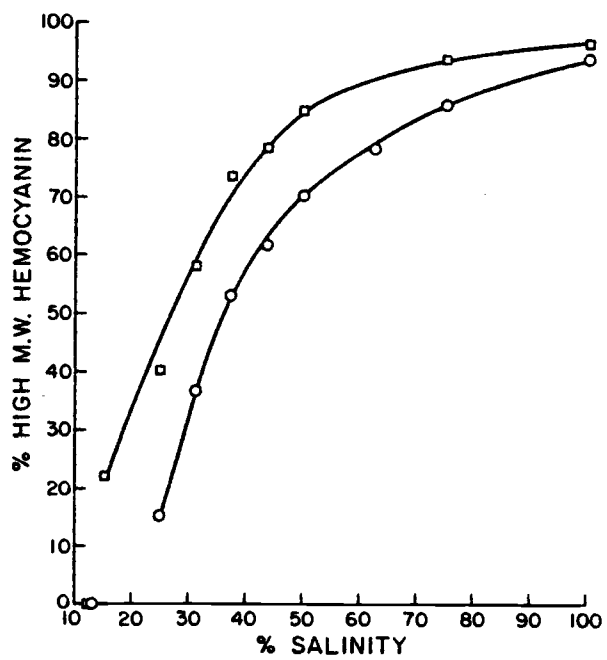

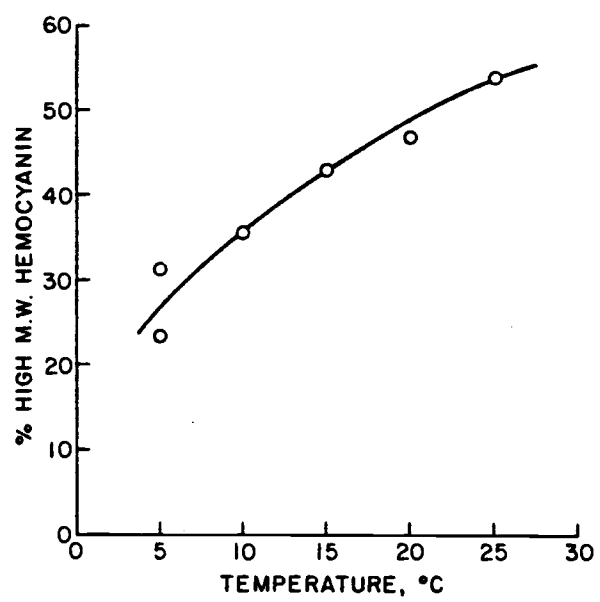

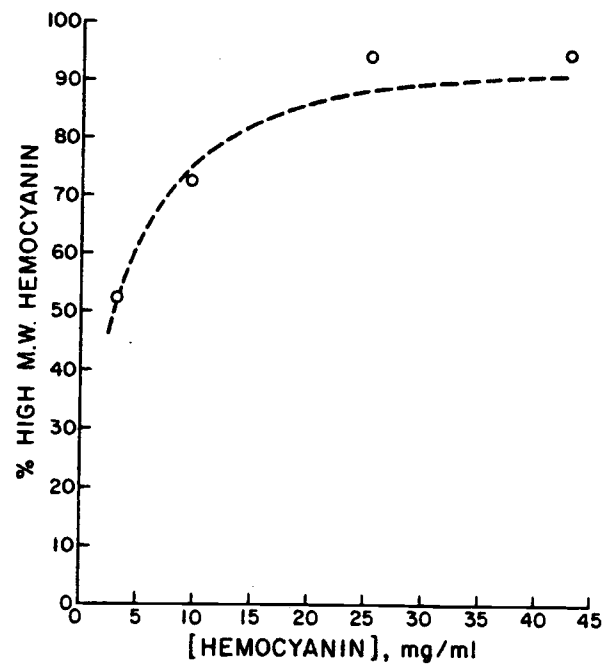

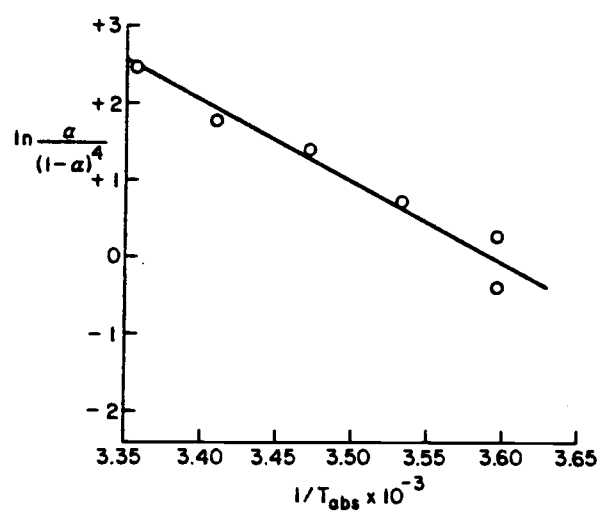



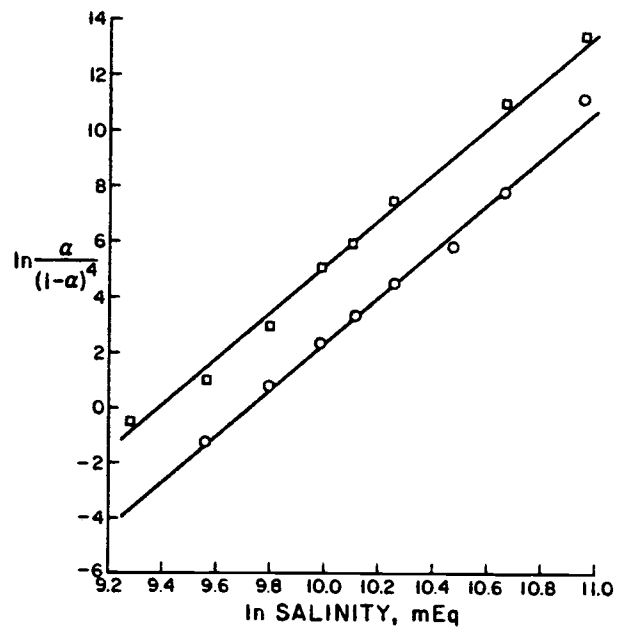

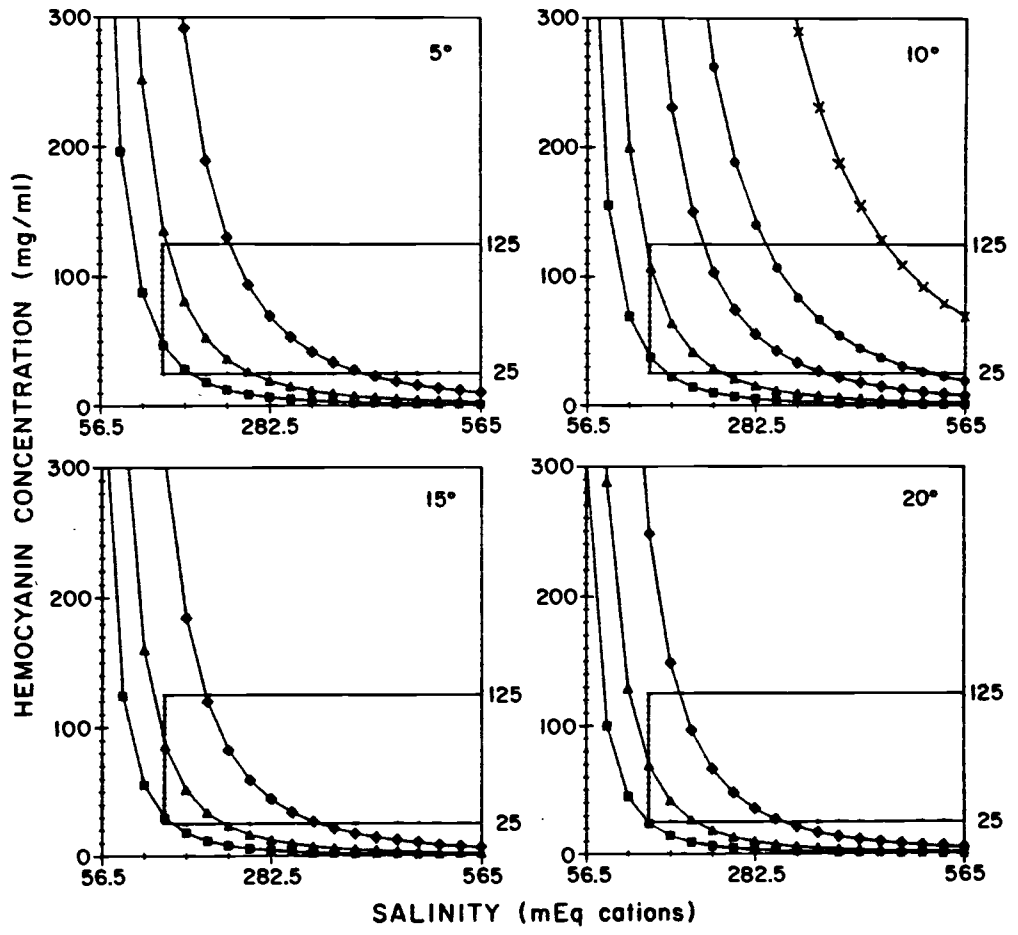

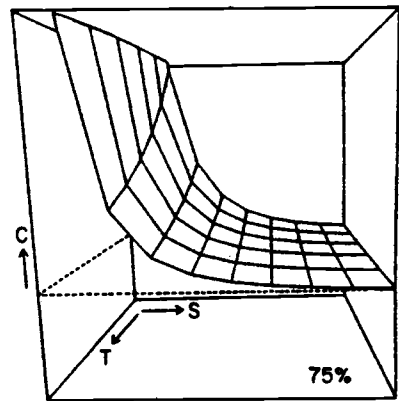
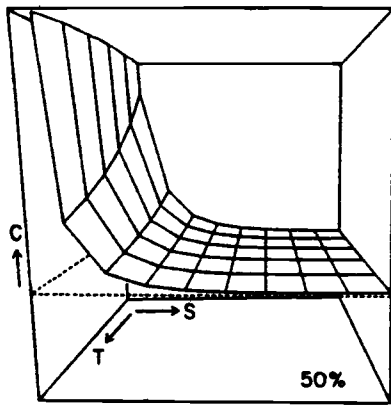
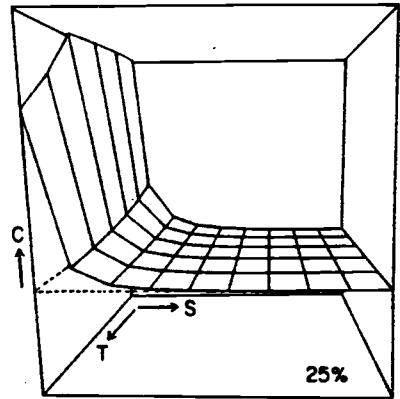
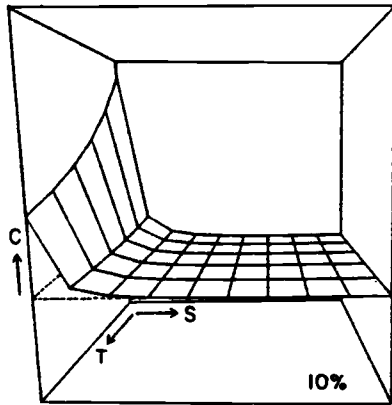

## REFERENCES

- Arisaka, F., Van Holde, K.E.: Allosteric properties and the association equilibria of hemocyanin from Callianassa californiensis. J. Mol. Biol. 134, 41-73 (1979)
- Blair, D., Van Holde, K.E.: Sedimentation equilibrium studies of a complex association reaction. Biophys. Chem. 5, 165-170 (1976)
- Mangum, C.P.: The influence of inorganic ions and pH on HCO<sub>2</sub> transport systems. In: Invertebrate Oxygen Binding Proteins. Lamy, J., Lamy, J., (Eds.) New York: Marcel Dekker (In press, a)
- Mangum, C.P.: Oxygen transport in the blood. In: Biology of Crustacea, Vol. II. Mantel, L.H. (Ed.). New York: Academic Press (In press, b)
- Mangum, C.P., Towle, D.W.: Physiological adaptation to unstable environments. Amer. Scient. 65, 67-75 (1977)
- Miller, K.I., Van Holde, K.E.: The effect of environmental variables on the structure and function of hemocyanin from Callianassa californiensis. I. Oxygen binding. J. Comp. Physiol. (1981) In press
- Roxby, R., Miller, K., Blair, D.P., Van Holde, K.E.: Subunits and association equilibria of Callianassa californiensis hemocyanin. Biochem. 13, 1662-1668 (1974)
- Schachman, H.S.: Ultracentrifugation in Biochemistry. p. 122. New York: Academic Press (1959)
- Thompson, L.C. and Pritchard, A.W.: Osmoregulatory capacities of Callianassa and Upogebia (Crustacea:Thalassinidea) Biol. Bull. 136, 114-129 (1969).
- Thum, A.B.: An ecological study of Diatomovora amoena, an interstitial Acoel flatworm, in an estuarine mudflat on the central coast of Oregon. Ph.D. thesis, Oregon State University (1972)
- Van Holde, K.E., Blair, D., Eldred, N., Arisaka, F.: Association equilibria of Callianassa hemocyanin. In: Structure and Function of Haemocyanin, Bannister, J.V. (Ed.). Berlin-Heidelberg: Springer-Verlag (1977)
- Weiland, A.L., Mangum, C.P.: The influence of environmental salinity on hemocyanin function in the blue crab, Callinectes sapidus. J. Exp. Zool. 193, 265-273 (1975).